

THE COMPLETE RANGE 2023

THE ESSENTIAL GUIDE FOR ON-COURSE
ACCESSORIES AND EQUIPMENT

masters27
EUROPE



WE'RE ON THE GREEN...



GREEN PACKAGING

With nearly 500 product lines in our accessory offering, we realise the kind of impact that using plastic was having on the environment. In 2019, we took the decision to eradicate plastic entirely from our accessory range and have since fed this into other areas of the business with a 'zero plastic first' mindset when packaging products.

In some cases, we're able to offer biodegradable products where possible with our Bamboo tees being the first to adopt this new way of packaging.



GREENER PRODUCTS

It's one thing to adopt a zero plastic policy with our packaging, but we have now shifted our thinking as to how we can create products in a more sustainable way. Replacing plastic tees with bamboo or biodegradable options is one of our key initiatives and we are working hard to bring to market these options in the near future.

Furthermore, whilst we understand plastic is incredibly durable and in some case ideal for some of our products, we are entering a new era where product design is considered from a new perspective, exchanging single use for sustainable and continuing to serve quality and value as we always have.



GREEN DEVELOPMENT

In May 2022, we entered a new and exciting partnership with Edinburgh Napier University to support their research into the possibility of converting wood and bamboo sawdust into usable material for construction, packaging and most importantly to us, golf tees.

With our extensive knowledge of golf tee production, we are advising on the project in a supportive capacity to help with product development. As industry leaders in golf tee production, we feel it is pertinent to be involved in the development of new materials, processes and ways we can contribute to a greener future for the sport we love.

Our previous plastic accessory 'blister' packaging.



Accessory packaging that is 100% recyclable and uses far less space in transit.

ERADICATING PLASTICS

In 2019, we took the decision to eradicate plastic packaging entirely from our accessory range. We are now in a position where 90% of our current accessory range boxes are smaller than the previous 'blister' plastic packaging.

But not only have we reduced the amount of plastic, but we have also reduced the amount of 'air' that needs to be shipped. Fuller containers that are imported without wasting space has now been made possible with our cardboard packaging.

90%

of our current accessory range boxes are smaller now that they are not made of plastic.

0.11m³

is the average size of an outer packaging box, equivalent to saving 0.06m³ on every box containing cardboard packaging.

950

the amount of outer boxes that a 40ft shipping container can hold, vastly reducing the amount of actual containers needed to transport product.

PLASTIC TEES TURN OFF...

In July 2022 we made the decision as a business to stop manufacturing plastic tees. The Masters Golf brand has been synonymous with the supply and production of plastic tees made here in the UK, but as we near the end of our plastic tee stocks, we are embarking on a new and exciting journey where sustainability will be our primary focus.

Already we are seeing the benefit of using bamboo as our primary tee, but future developments into biodegradable materials is well underway.

See the diagram (right) for our sustainable tee production which we hope to launch in 2023.



Plastic Tees will no longer be part of the Masters 24/7 range.

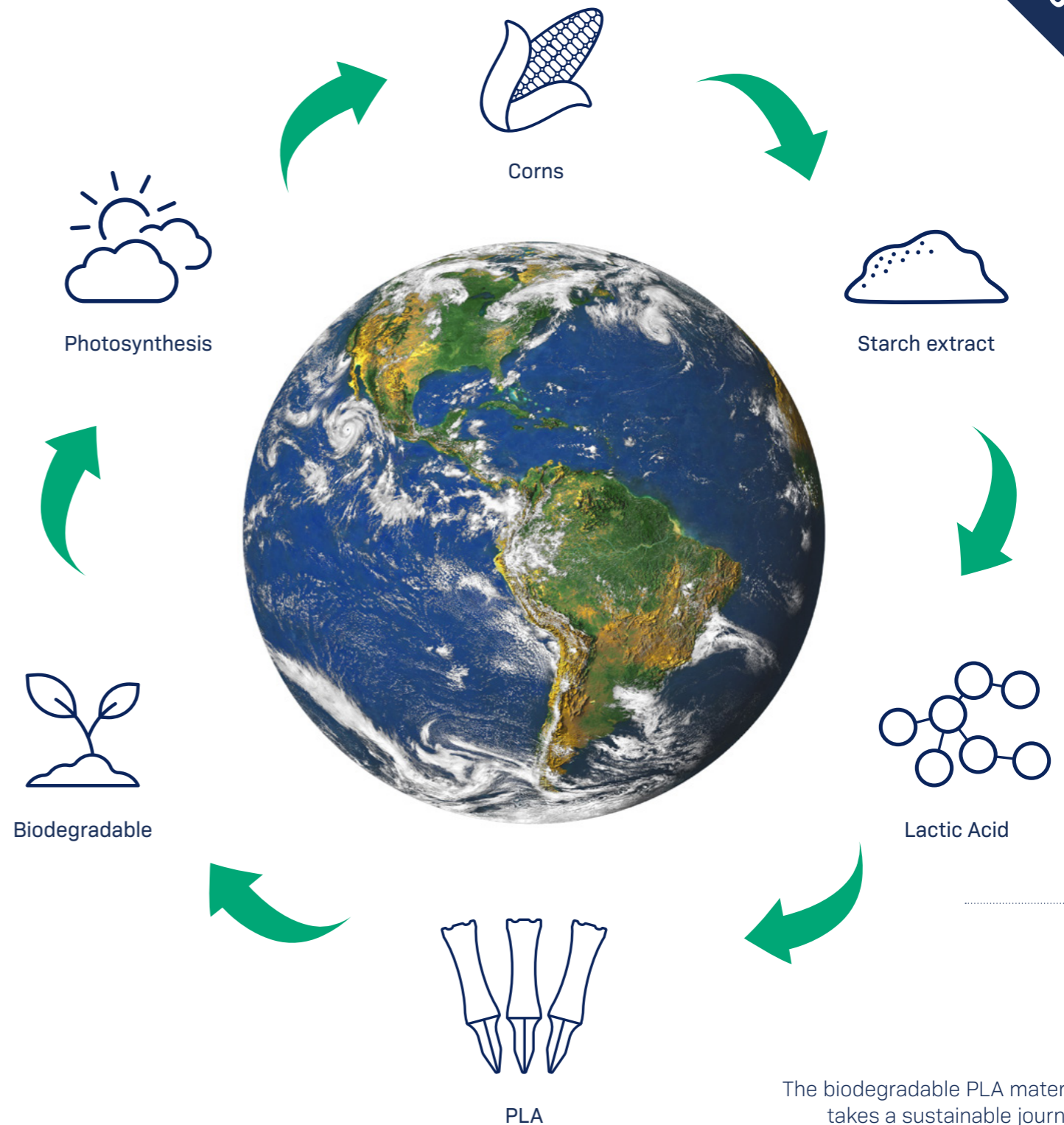

The biodegradable PLA material takes a sustainable journey which is illustrated here.

Coming soon...

DRIVING RANGE

PRACTICE STUDIO

JUNIOR GOLF

HEADCOVERS

CLUBS & CLUB SETS

UMBRELLAS

BAGS & TROLLEYS

FLIGHT COVERS

GOLF BALLS & RETRIEVERS

GLOVES

CONSUMABLES

CLEATS

ACCESSORIES

TEES

TEES



CLEANER, CLEARER & RESPONSIBLE

MAKE YOUR RETAIL OPERATIONS FLY BY MAKING THE SWITCH TO BAMBOO AND OFFER YOUR CUSTOMERS THE SUSTAINABLE CHOICE.

As part of our attempt to provide customers with more sustainable choices, we've introduced both standard and graduated bamboo tees to our range of tees.

Made from sustainably sourced bamboo, coloured with water based inks and fully biodegradable – these tees are a great alternative to plastic. What's more, they are packaged in a fully biodegradable bag meaning that they can be added to the greenkeepers compost heap when finished with!



BAMBOO WHITE

SUSTAINABLE TEES

We're replacing our own branded tees from wood to bamboo in attempt to provide our customers with more sustainable choices.

Made from sustainably sourced bamboo, these tees are not only a great green story but are fully bio-degradable and a great alternative to wooden tees making them better for the course, and the environment. Comes in 100% biodegradable packaging.

CODE	SIZE	BAG QTY
TEB0005	3¼"	Bag of 15
TEB0006	2¾"	Bag of 20
TEB0007	2½"	Bag of 25
TEB0050	3¼"	Bag of 85
TEB0051	2¾"	Bag of 110
TEB0052	2½"	Bag of 130



BAMBOO GRADUATED

SUSTAINABLE TEES

As part of our attempt to provide customers with more sustainable choices, we've introduced graduated bamboo tees to our unbeatable range of tees.

Made from sustainably sourced bamboo, coloured with water based inks and fully bio-degradable – these tees are a great alternative to plastic. Comes in 100% biodegradable packaging.

CODE	SIZE
TEB0020	2¾" Orange
TEB0021	2¼" Pink
TEB0022	2" White
TEB0023	1½" Blue
TEB0024	1¼" Red
TEB0025	1" Lime

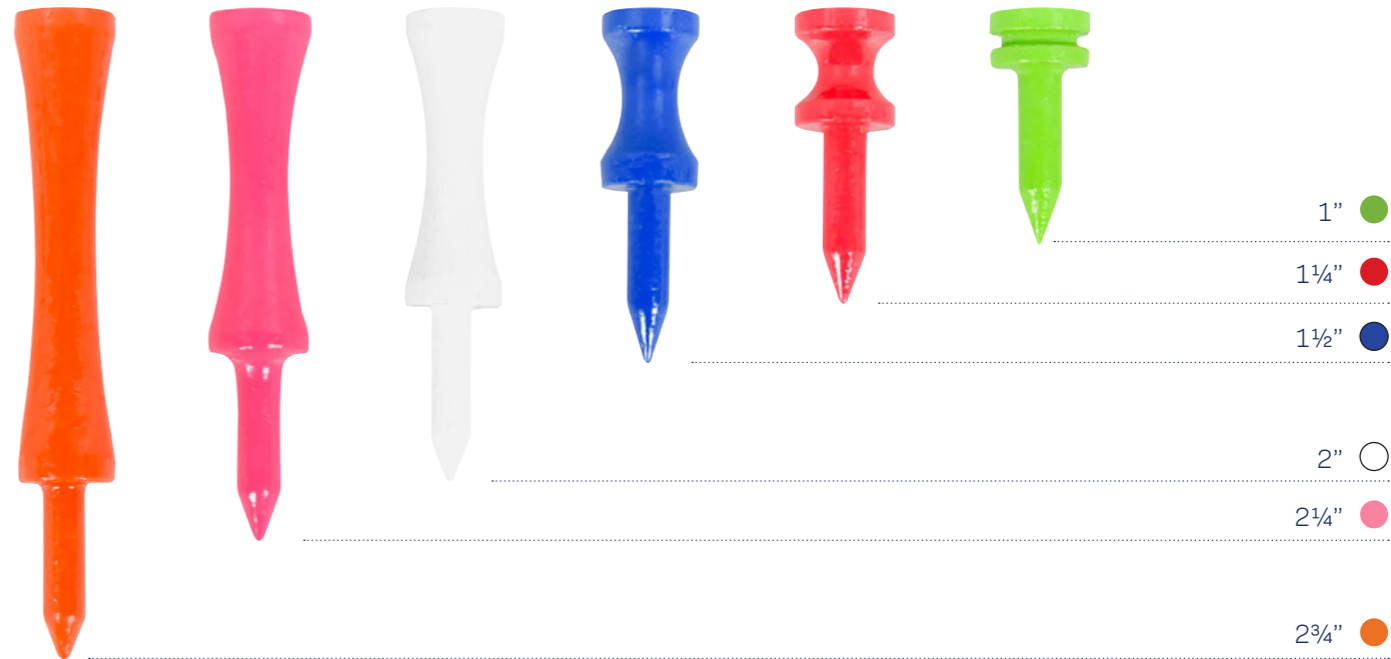

PRIDE PTS

WOODEN TEES

Professional Tee System (PTS) by Pride Golf Tees. 100% solid hardwood and colour coded for helping with length identification.

CODE	SIZE	BAG QTY
TEWPT10	1½"	Bag of 90
TEWPT11	2⅛"	Bag of 120
TEWPT12	2¾"	Bag of 100
TEWPT13	3¼"	Bag of 75



MINITEE™ 1½"

SHORTEE™ 2⅛"

PROLENGTH™ 2¾"

PROLENGTH-PLUS™ 3¼"



GREENUP TEES

100% BIODEGRADABLE TEES

Go green and play sustainably with less waste. The Greenup Golf tee is made of high quality biomaterial and coffee waste. There's no plastic or wood involved in it's structure – it's 100% biodegradable and environmentally friendly.

Greenup collects coffee waste from cafés and restaurants to minimise waste and cut off wood and plastic from the production. Thereby, Greenup delivers golf tees made of completely natural and biodegradable material.

CODE	SIZE	BAG QTY
TEGR001	2¾"	Bag of 20
TEGR005	2¾"	Bag of 100



2¾"

TEES

ACCESSORIES

CLEATS

CONSUMABLES

GLOVES

GOLF BALLS & RETRIEVERS

FLIGHT COVERS

BAGS & TROLLEYS

UMBRELLAS

CLUBS & CLUB SETS

HEADCOVERS

JUNIOR GOLF

PRACTICE STUDIO

DRIVING RANGE

ACCESSORIES

02

- TEES
- ACCESSORIES
- CLEATS
- CONSUMABLES
- GLOVES
- GOLF BALLS & RETRIEVERS
- FLIGHT COVERS
- BAGS & TROLLEYS
- UMBRELLAS
- CLUBS & CLUB SETS
- HEADCOVERS
- JUNIOR GOLF
- PRACTICE STUDIO
- DRIVING RANGE

ACCESSORY SLATWALL

CREATE A SET UP LIKE THIS with
MASTERS GOLF



*Image for illustration purposes only.

ACCESSORY SLATWALL

SUGGESTED PRODUCT PACK

CODE	PRODUCT
ZDTE0080	St Andrews Deluxe Pitchfork
ZDTE0068	Switchblade Style Pitchfork silver
ZDTE0054	Deluxe Pitchfork With Marker
ZDTE0040	Neon PitchFork & Ball Markers X 2
ZDTE0030	Neon Ball Markers X 12
ZDTE0022	Super Deluxe Society Pack
ZDTE0020	Deluxe Society pack
ZDTE0000	Jumbo Pyramid Tee Stringed
ZDSA0025	Ultra Pro Spike Wrench
ZDSA0015	Deluxe Pro Wrench
ZDGB0026	Airflow XP Practice Balls Pink pack 6
ZDGB0022	Airflow XP Practice Balls Yellow pack 6
ZDGB0020	Airflow XP Practice Balls White pack 6
ZDGB0010	Striped Foam Practice Balls pack 6
ZDGA0221	Retract Holder with Pencil
ZDGA0200	Lead Weights Strips X 8
ZDGA0169	Cap Clip & Ball Marker
ZDGA0162	Putter Clip & Ball Marker
ZDGA0126	3-in-1 Multi Cleaner Brush
ZDGA0122	Opti Club Cleaner Brush
ZDGA0120	Water Bottle Club Cleaner
ZDGA0102	Trolley Webbing Straps x 2
ZDGA0100	Trolley Elastics X 2
ZDGA0082	Waterproof Ball Marker Pens X 2
ZDGA0080	Align-M-Up Ball System
ZDGA0073	Deluxe 2 In 1 Scorer Red/Black
ZDGA0064	Bag Tag Scorer
ZDGA0062	Score Card Counter
ZDGA0060	Bead Counter
ZDGA0050	Premium Leatherette Scorecard Holder
ZDGA0042	Deluxe Score Card Holder
ZDGA0040	Score Card Holder
ZDGA0020	Ball Cleaner and Tee Holder
ZDGA0000	Tee Holder
ZDBR0010	Golf Butler
ZDBR0000	Green Gripper



BALL CLEANER

WITH TEE HOLDERS

A handy accessory which comes with an elasticated loop enabling it to be hung on a golf bag. Also features six holes for holding tees.

CODE

ZDGA0020

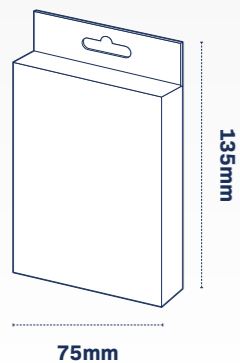

WATER BOTTLE CLEANER

KEEPS CLUBS DIRT-FREE

A simple way to keep your clubs clean throughout a round. Also features a clip allowing it to be hung on a golf bag.

CODE

ZDGA0120

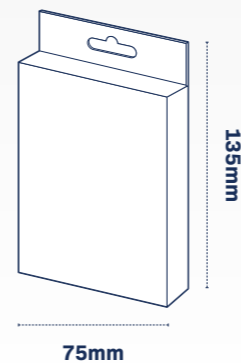

OPTI CLEANER BRUSH

WITH CARABINER CLIP

The Opti Cleaner brush comprises a nylon brush and a brass brush in one handy tool to enhance club performance.

CODE

ZDGA0122

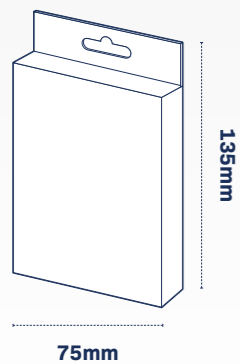

3-IN-1 MULTI CLEANER

KEEPS CLUBS DIRT-FREE

Combining a brass brush, a nylon brush and a club groove cleaner this handy tool is great for keeping your club's performance in check.

CODE

ZDGA0126

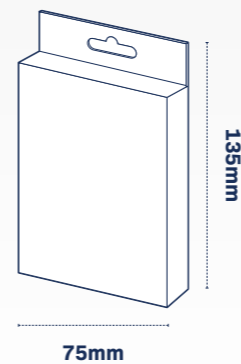

ALIGN-M-UP BALL SYSTEM

ACCURATE BALL MARKING

Mark your golf ball permanently aiding identification, sink more putts, nail more fairways and lower your score.

CODE

ZDGA0080

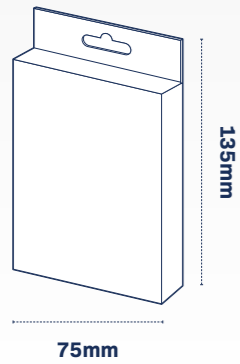

MASTERS GOLF



ALIGNMENT TOOL

BY SOFTSPIKES

The SoftSpikes Golf Ball Alignment Tool is the only tool that marks both sides of the ball. It features a Putter Squareness Line for keeping the putter face square through impact and a Swing Path Reminder Line to help promote a proper swing path.

CODE

GA140

Softspikes



WOOD PENCILS

WITH ERASER AND CLIP

A quality and practical golf pencil that comes with a handy clip and eraser, ideal for on-course scoring. Pack contains 5 pencils.

CODE

ZDGA0140

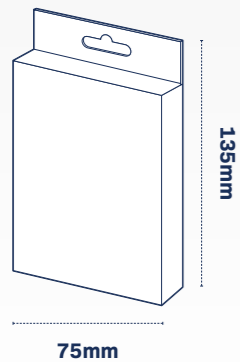

MASTERS GOLF



WATERPROOF MARKERS

GREAT FOR BALL MARKING

These pens will mark your golf ball permanently, aiding identification.

CODE

ZDGA0082

MASTERS GOLF

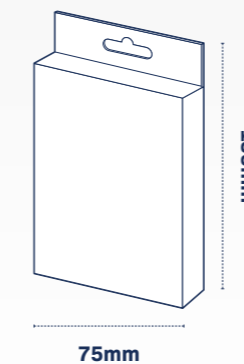

SHARPIE MARKERS

PERMANENT BALL MARKING

Remarkably resilient ink dries quickly and resists both fading and water; AP certified and can be used to mark almost any surface, ideal for identifying golf balls.

CODE

GA074A



Sharpie

SHARPIE MARKERS

MINI MIXED TUB OF 72

72 mini permanent markers that provide quality, fast drying ink and can be used to mark almost any surface, ideal for identifying golf balls.

CODE

GA074C

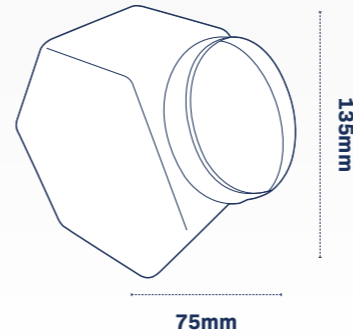

Sharpie

JUMBO PYRAMID TEES

USE ON FROZEN OR HARD GROUND

The Jumbo Pyramid Tees have been specifically designed for use on frozen ground or mats, meaning you can carry on playing whatever the weather.

CODE

ZDTE0000

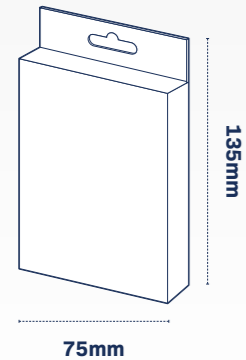

 **MASTERS GOLF**



POCKET BALL-KLEEN

PACK OF 2

Compact, super light and washable, the Pocket Ball-Kleen is the perfect partner on the course. Fits into your pocket with ease and will clean golf balls effortlessly.

CODE

GABZ02

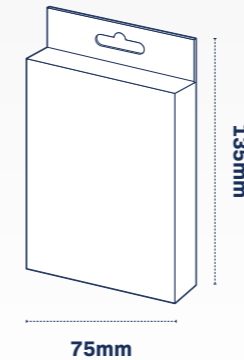

 **MASTERS GOLF**



BALL MARKERS x12

NEON COLOUR STYLE

Brightly coloured ball markers allow you to mark the position of the ball when it is in the line of your opponent's putt.

CODE

ZDTE0030

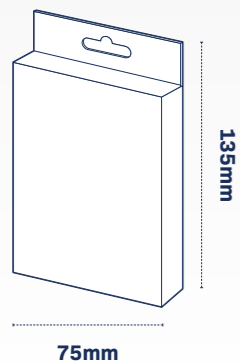

PITCHFORK & MARKERS

NEON COLOUR STYLE

A pack of 2 divot repair tools and 2 ball markers. Made in bright neon colours to ensure that both the pitchmark repairers and ball markers are easy to find.

CODE

ZDTE0040

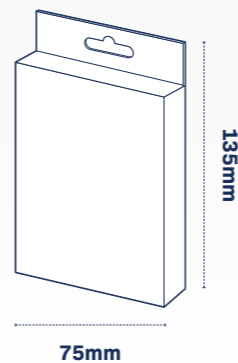

DELUXE PITCHFORK

WITH BALL MARKER

A lightweight but durable pitchfork with a ball marker that simply clips in and out via a spring, making it easy and quick to use.

CODE

ZDTE0054

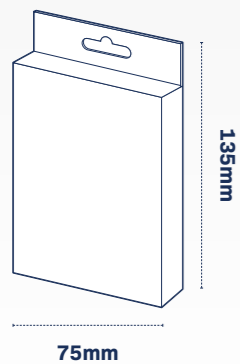

SWITCHBLADE PITCHFORK

WITH MAGNETIC BALL MARKER

The 'switchblade' style pitchfork springs out with the press of a button, and folds back into the handle. It also features a detachable ball marker.

CODE

ZDTE0068

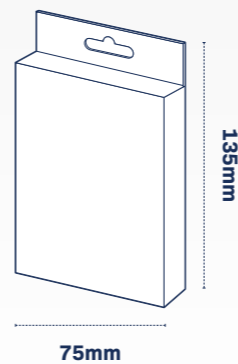

DELUXE 2-IN-1 SCORER

DUAL SCORE COUNTER

A simple and effective way to keep score on the course. Designed for use of up to 2 players and shows the strokes taken for each player on the present hole.

CODE

ZDGA0070

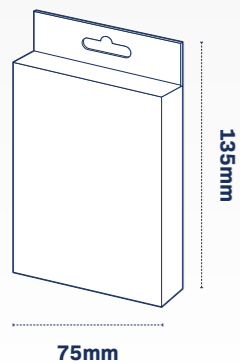

BEAD COUNTER

FOR STROKE COUNTING

A simple and very effective way to keep your score on the golf course. Counts up to 10 strokes per hole.

CODE

ZDGA0060

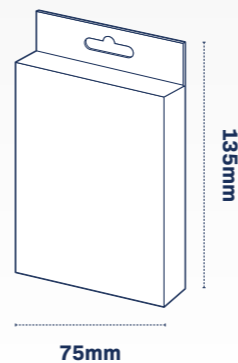

SCORECARD COUNTER

FOR STROKE COUNTING

A re-usable and durable way to keep your score, round after round. Features a metal carabiner clip to attach it to your golf bag.

CODE

ZDGA0062

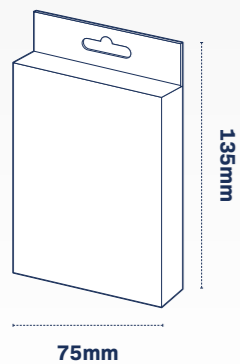

BAG TAG SCORER

FOR STROKE COUNTING

A re-usable and durable way to keep your score, round after round. Features a metal clip to attach it to your golf bag.

CODE

ZDGA0064

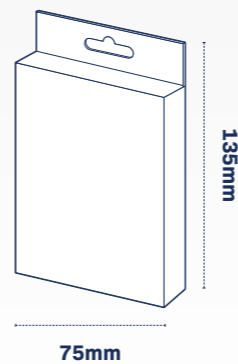

CLEAT WRENCH

FITS MOST CLEAT DESIGNS

Replacing and tightening spikes is made easy with the Cleat Wrench. It has a large nylon handle giving great grip and the solid construction ensures a lifetime of service.

CODE

ZDSA0015

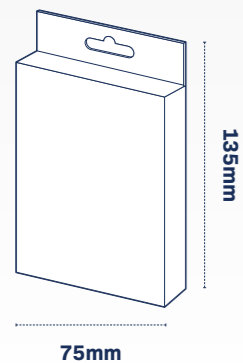

CLEAT MASTER

MULTI-PURPOSE SPIKE WRENCH

Features spike, cleat and Philips screw driver head attachments. Large ergonomic handle offers great grip and a handy 'flick switch' allows tightening or removal.

CODE

ZDSA0010

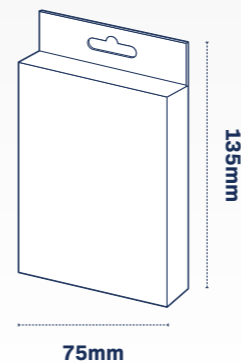

ULTRA PRO WRENCH

FITS MOST CLEAT DESIGNS

The Ultra Pro Spike Wrench comes with a large Soft-Grip handle offering a firm hold and the solid construction ensures a lifetime of service.

CODE

ZDSA0025

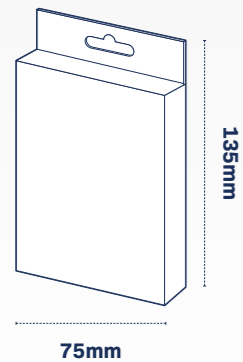

CLEAT RIPPER

FITS ALL CLEAT DESIGNS

Comes with a large ergonomic handle offering a firm hold and the aggressive prong design rips out all stubborn cleats.

CODE

ZDSA0020



SCORECARD HOLDER

WITH PENCIL & SCORING CHART

A protective case for your score card, keeping it dry and providing a firm writing surface. It features a handicap calculator, score card clip and a pencil.

CODE

ZDGA0042

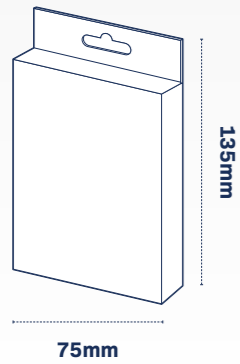



SCORECARD HOLDER

PREMIUM SOFT FEEL FINISH

A leatherette protective case for your scorecard, keeping it dry and providing a firm writing surface. Comes with elasticated internal holders for card and pencil.

CODE

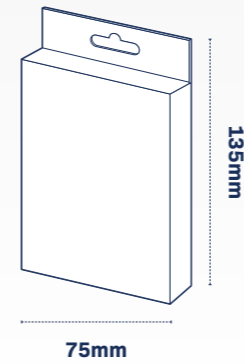
ZDGA0050



SOCIETY PACK

ESSENTIALS ACCESSORY PACK

Pack contains:

- 10 x 2¾" tees
- 6 x 2½" tees
- 2 x ball markers
- 1 x pencil with eraser
- 1 x metal pitchfork with spike key

CODE

ZDTE0020

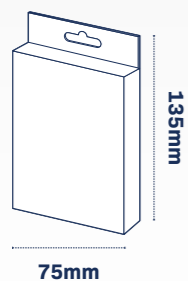

XL SOCIETY PACK

EXTENSIVE ACCESSORY PACK

Pack contains:

- 40 x 2¾" tees
- 40 x 2½" tees
- 1 x optimiser brush
- 1 x winter tee set
- 1 x bead stroke counter
- 1 x metal pitchfork with spike key
- 6 x ball markers
- 1 x waterproof marker pen

CODE

ZDTE0022



30% DISTANCE BALLS

PACK OF 6

Travelling at only 30% of the true distance allowing practice of swings in smaller space without the worry of damage to property.

CODE
ZDGB0000

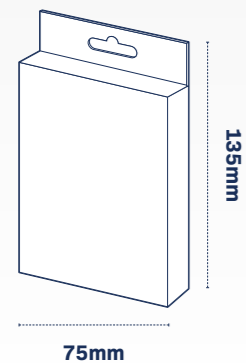

STRIPED FOAM BALLS

PACK OF 6

Weighing in at only 4g, the Foam Practice Balls allow for safe use in confined areas whether in the back garden or indoors.

CODE
ZDGB0010

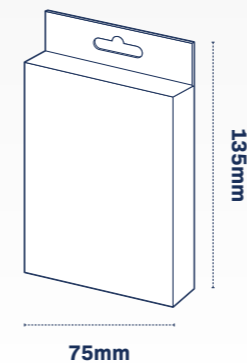

AIRFLOW PRACTICE BALLS

PACK OF 6

The scalloped holes of the Airflow XP make the ball fly true off the club face simulating the flight of a real ball.

CODE

ZDGB0022	
ZDGB0024	
ZDGB0026	
ZDGB0020	

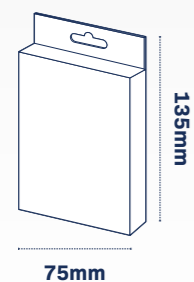

FOAM PRACTICE BALLS

PACK OF 6

This practice ball mimics the flight of a standard golf ball but is made from a very soft compound and is safe for use in all confined areas.

CODE

ZDGB0005	
ZDGB0006	

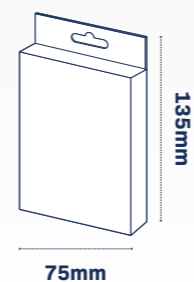

CLEATS



TOUR FLEX PRO

SOFTSPIKES

The new Tour Flex Pro cleats are the most recent innovation in cleat technology by SoftSpikes. Born in the lab and proven on the course, the Tour Flex Pro features three degrees of traction and ten points of contact designed to deliver incredible control and unmatched stability.

CODE	DESCRIPTION
SAST002	1 Set
SAST001	Display 24x



FLEXIBLE LEGS

Designed to expand and grip the course.

TRACTION SPIKES

For ultimate stability and control.

CENTRE STINGER

Ideal for anchoring support and balance.

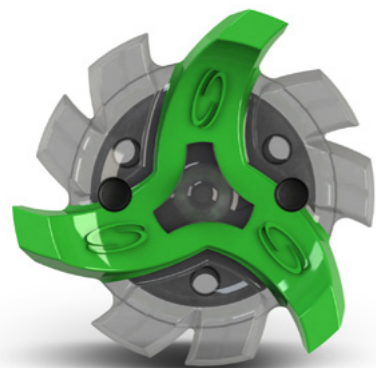

CHAMP PRO STINGER

FASTTWIST 3.0 THREAD

Play in any weather with this soft durometer TPU providing superior comfort and durability. The metal tip provides unsurpassed traction with non clogging support pods.

CODE

SACH050

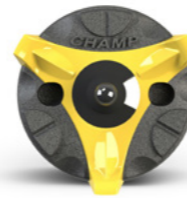

CHAMP UNDER ARMOUR

SLIM LOK ZARMA

Zarma Tour spikes feature 6 flexible, anti-clogging comfort legs and a low-profile design for a secure grip and superior green friendliness.

CODE

SAUA001



SOFTSPIKES SILVER TORNADO

FASTTWIST THREAD

The Silver Tornado cleats feature the Fast Twist® 3.0 insert system which utilizes SoftSpikes latest technology, Cross System Protection™ (CSP) assuring that only cleats with CSP can be installed.

CODE

SAST050



SOFTSPIKES BLACK WIDOW

FAST TWIST 3.0 OR Q-LOK

The dynamic movement of DCT gives Black Widow exceptional grip, and allows the cleat to flex on putting surfaces for unmatched green friendliness, while also providing best-in-class traction and comfort for golfers

CODE FITMENT

SASB25 FT 3.0

SASB30 Q-LOK

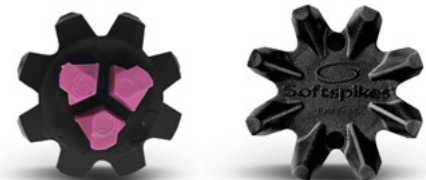
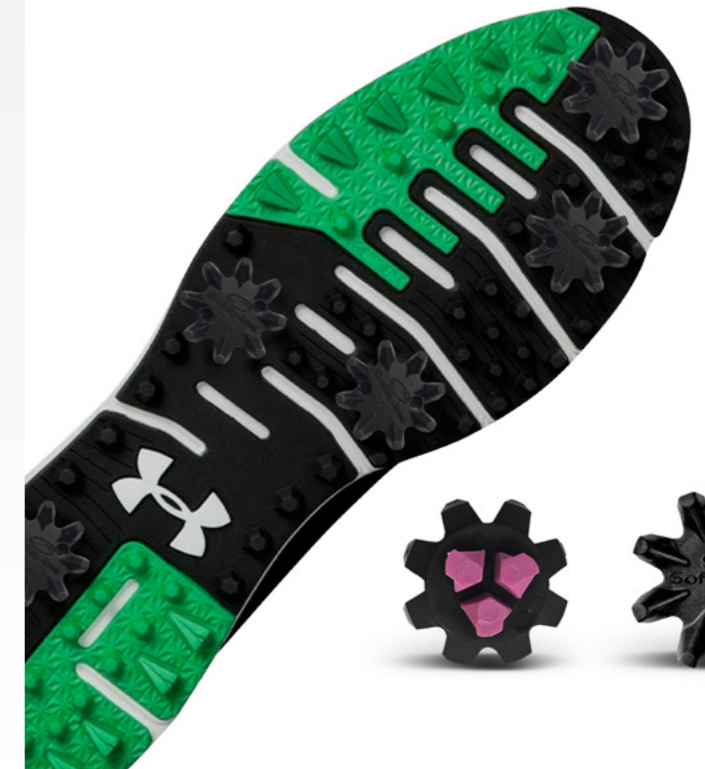
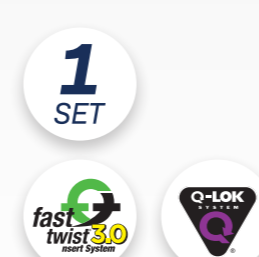

SOFTSPIKES PIVIX

FAST TWIST 3.0 THREAD



Pivix golf cleats feature reinforced Spring Flex legs, which provides ultimate traction and stability throughout your swing.

CODE

SASP60



SOFTSPIKES CYCLONE

FASTTWIST THREAD



Cyclone is a multi-material cleat with an advanced rotational design to counteract the forces seen during impact.

CODE

SASC06

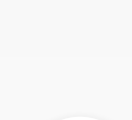

SOFTSPIKES STEALTH

PINS THREAD



The Stealth cleat is offered exclusively in the PINS insert system. The low-profile design allows golfers to feel closer to the ground and harness their highest level of balance and stability.

CODE

SASF001



SOFTSPIKES PULSAR

VARIOUS FITMENTS



Pulsar delivers maximum comfort and performance via a 16 component design that reacts to every angle of force exerted by the golfer.

CODE **FITMENT**

SASP00 6mm

SASP04 FT 3.0

SASP05 PINS

SASP504
(bowl of 400) FT 3.0



GLOVES

035

RX ULTIMATE GLOVE

ALL WEATHER GLOVE

The Masters Golf 'RXUltimate' glove offers all weather lasting performance and fit using advanced materials and the ultimate in high-tech fabrics.

Gents L/H

CODE	SIZE
GLOV115	S
GLOV116	M
GLOV117	M/L
GLOV118	L
GLOV119	XL

Gents R/H

CODE	SIZE
GLOV135	S
GLOV136	M
GLOV137	M/L
GLOV138	L
GLOV139	XL

Ladies L/H

CODE	SIZE
GLOV143	S
GLOV144	M
GLOV145	L
GLOV146	XL

FREE

Purchase 100 gloves and receive 100 personalised domed discs free of charge

Choose from RDAD26D-AS/GM or AG for finish



Additional patch on palm for extra grip and durability

Advanced RX 'honeycomb' fabric

Cool flexible Lycra helps airflow and gives consistent movement

Detachable magnetic ball marker

CABRETTA GLOVE

100% LEATHER GLOVE

Premium cabretta leather offering superb feel, fit & comfort. Provides a soft, smooth feel for a consistent fit, flexibility and increased breathability. Accessorised with a detachable magnetic ball marker.

Gents L/H

CODE	SIZE
GLOV280	S
GLOV281	M
GLOV282	M/L
GLOV283	L
GLOV284	XL

Gents R/H

CODE	SIZE
GLOV290	S
GLOV291	M
GLOV292	M/L
GLOV293	L
GLOV294	XL

Ladies L/H

CODE	SIZE
GLOV300	S
GLOV301	M
GLOV303	L

FREE Purchase 100 gloves and receive 100 personalised domed discs free of charge
Choose from RDAD26D-AS/GM or AG for finish

Superb soft feel and comfort with a consistent fit



Flexibility and increased breathability

Detachable magnetic ball marker

TOURDRI RAIN GLOVE

SUPERB CONTROL IN THE WET

The perfect way to tackle wet weather golf. The TourDri rain glove features a durable microfibre design that has more grip the wetter it gets.

Incorporating a mesh top to provide excellent moisture control, the glove allows the hand to flex naturally for an improved comfortable fit.

Gents Pair

CODE	SIZE
GLOV310	S
GLOV311	M
GLOV312	M/L
GLOV313	L
GLOV314	XL

Ladies Pair

CODE	SIZE
GLOV320	S
GLOV321	M
GLOV322	L



GRIP TRACTION

Designed specifically with microfibre suede to actively increase grip traction as the exterior becomes wet.



COMFORTABLE FLEX FIT

A stretchable mesh top provides excellent moisture control and flexibility for when holding a club.



TOUCH & FEEL

The soft, durable and fast drying glove material is even usable on capacitive smart devices, meaning you won't need take your glove off.



MKIDS JUNIOR GLOVE

PROGRESSIVE SIZING

Our MKids Golf gloves are available in four colour-coded sizes and feature a high tech water-resistant fabric for use all year round.

Junior L/H

CODE	SIZE	COLOUR
JUGL5WOS	S	Orange
JUGL6WRM	M	Red
JUGL7WGL	L	Green
JUGL8WLX	XL	Blue

Junior R/H

CODE	SIZE	COLOUR
JUGR5WOS	S	Orange
JUGR6WRM	M	Red
JUGR7WGL	L	Green
JUGR8WLX	XL	Blue



Additional patches on palm for extra grip and durability



Flexibility and increased breathability

Embossed rubber MK Logo

GOLF BALLS & RETRIEVERS



PRISMA TITANIUM

BOX OF 12x BALLS

The two piece construction is designed to produce extra length off the tee and is ideal for beginners and high-handicap players. A unique dimple design and surlyn cover ensures optimum trajectory and feel.

CODE	COLOUR
GBP001	Orange
GBP002	Pink
GBP003	White
GBP004	Yellow

PRISMA



PRISMA FLUORO

BOX OF 12x MATTE FINISH BALLS

The two piece construction is designed to produce extra length off the tee and is ideal for beginners and high-handicap players. A unique dimple design and surlyn cover ensures optimum trajectory and feel.

CODE	COLOUR
GBP010	Fire Orange
GBP011	Hot Pink
GBP012	Acid Lemon
GBP013	Flame Red

PRISMA



SUPERLITE BALL RETRIEVER

EXTENDS UP TO 3m

Simply push the white button on the end cap and with a flick of the wrist the telescopic shaft extends to the desired length. Telescopic shaft features with tighten and loosen adjustments helps to secure position when extended.

CODE
BR18



SUPERLIGHT DESIGN

Lightweight and compact, perfect for carrying around in your golf bag.

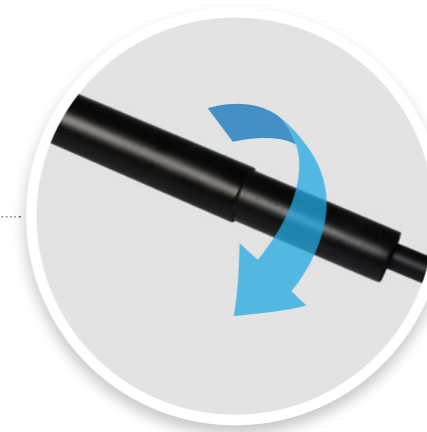

TELESCOPIC SHAFT

Designed with tighten and loosen adjustments to help secure position when extended.

- TEES
- ACCESSORIES
- CLEATS
- CONSUMABLES
- GLOVES
- GOLF BALLS & RETRIEVERS
- FLIGHT COVERS
- BAGS & TROLLEYS
- UMBRELLAS
- CLUBS & CLUB SETS
- HEADCOVERS
- JUNIOR GOLF
- PRACTICE STUDIO
- DRIVING RANGE

BALL RETRIEVERS

ROBUST AND STURDY

Perfect for capturing stray balls – whether in a pond, or beyond a boundary fence. By extending the pole to the desired length you can quickly and simply scoop up your golf ball without any accidents.

The automatic locking device on the scoop prevents the golf ball from being dropped on retrieval.

CODE	LENGTH
BR07B	3m
BR12S	4.5m
BR13S	5.5m



BALL RETRIEVERS

SUPER COMPACT & LIGHTWEIGHT

Easily retrieve your golf ball from hard to reach places by extending the pole to the desired length you can quickly and simply scoop up your golf ball with ease.

CODE	LENGTH	TRADE
BR08B	3m	
BR09B	2m	



ORIGINAL CLIKKA TUBE

HOLDS UP TO 20 BALLS

The Klikka Tube provides a simple and effective way of collecting golf balls to save users straining their back and muscles.

Its one-way catch system keeps them from falling out once collected and it can hold up to 20 balls at a time

CODE

BR020



ORIGINAL CLIKKA BAG

HOLDS UP TO 55 BALLS

The Masters Golf Klikka Bag can retrieve up to 55 balls from the ground. Lightweight and easy to use the Klikka Bag is ideal for transporting large amounts of golf balls to the practice area. The flip lid release allows for easy removal of the golf balls.

CODE

BR030



DELUXE SHAG BAG

HOLDS UP TO 85 BALLS

The Deluxe Shag bag can hold up to 85 golf balls and also acts as a practice ball bag ideal for transporting large amounts of golf balls to the practice area.

CODE

BR35B



EXTENDING BUNKER RAKE

EXTENDS UP TO 2.7m

The extendable bunker rakes multi function folding head provides easy storage when not in use and also performs two duties as a bunker rake and a ball retriever, saving space in the bag and weight when on the course.

Fully extended the bunker rake has a reach of 2.7 meters.

CODE **QTY**

BR15B

BR15B



FLIGHT COVERS



DRIVING RANGE
PRACTICE STUDIO
JUNIOR GOLF
HEADCOVERS
CLUBS & CLUB SETS
UMBRELLAS
BAGS & TROLLEYS
FLIGHT COVERS
GOLF BALLS & RETRIEVERS
GLOVES
CONSUMABLES
CLEATS
ACCESSORIES
TEES

ICART FLIGHT COVER

OPTIMUM CLUB PROTECTION

The iCart Flight travel cover is designed to keep your clubs safe during long travelling. This travel cover features superior quality with 20mm thick padding protects your clubs.

- Fits golf bags up to 10 inches
- 20mm padding for optimum club protection
- Lockable zips
- Ezi-Glide wheels

CODE

BA85BG



SECURE FASTENINGS

Thick webbing straps that are adjustable help keep contents safe and secure.



EASY HANDLING

Large durable handles make handling easy and ideal for moving heavy loads.



EASY TO MANOEUVRE

Ezi-Glide wheels on the bottom enable your equipment to be wheeled around reducing strain on the back and arms.

TRAVELTECH FLIGHT COVERALL

FITS GOLF BAGS UP TO 10"

Stylish and strong, helping to protect your golf bag and clubs on flights, transporting to the course, or when being stored.

The TravelTech Flight Coverall is made from a high-strength 1680D Ballistic Nylon for added protection and security. Finished with distinctive Masters Golf blackout branding.

CODE	QTY
BA66B	1
BA66B	4
BA66B	8



1180mm

370mm



SECURE PADDING

Shaped to fit the contours of all golf bags and clubs ensuring close fit and preventing excess movement inside.



STRONG & SECURE

Durable rubber zippers that enable padlocking which move easily along a chunky 10mm zip track.



EASY TO MANOEUVRE

Ezi-Glide wheels on the bottom enable your equipment to be wheeled around reducing strain on the back and arms.

LIGHTWEIGHT FLIGHT COVERALL

FITS GOLF BAGS UP TO 8½”

Shaped to fit the contours of your bag and clubs ensuring close fit and preventing excess movement inside. A major feature is the addition of wheels on the bottom enabling your equipment to be wheeled around reducing strain on the back and arms.

- Easy rolling wheels
- Padded construction for golf club protection
- Full length zip and front pocket

CODE	QTY
BA37B	1
BA37B	4
BA37B	8



1200mm

320mm



SMALL WHEN STORED

When not in use, the coverall folds down to around 10% its original size meaning it won't take up lots of room when not in use.



EASY ACCESS STORAGE

A large storage pocket is ideal for storing clothes or accessories.



EASY TO MANOEUVRE

Ezi-Glide wheels on the bottom enable your equipment to be wheeled around reducing strain on the back and arms.

STRONG ARM

CLUB PROTECTOR

Protect your clubs when travelling, the Strong Arm Club Protector extends and has a protective “umbrella” at the top to stop impacts being transferred to your clubs.

- Stops impact being transferred to your clubs
- Collapsed size: 67cm / extended size: 133cm

CODE	QTY
BA78	1



PROTECTION DURING TRANSIT

Comes with a protective and robust ‘umbrella’ at the top to stop impacts being transferred to your clubs



ADJUSTABLE HEIGHT

The Strong Arm has five height settings, meaning users can adjust the height to their desired level.



TEES

ACCESSORIES

CLEATS

CONSUMABLES

GLOVES

GOLF BALLS &
RETRIEVERS

FLIGHT
COVERS

BAGS &
TROLLEYS

UMBRELLAS

CLUBS &
CLUB SETS

HEADCOVERS

JUNIOR GOLF

PRACTICE
STUDIO

DRIVING
RANGE

BAGS & TROLLEYS



ICART VOLTA

360° ROTATING FRONT WHEEL

The brand new iCart Volta comes with a 360° rotating wheel for superb control and manoeuvrability on the course. The Volta benefits from all the features that are common in all iCart models but with the added benefit of hand controlled brake and front wheel lock.

Also comes with a base unit for umbrella holder, valuables case and elasticated storage pocket.

CODE	COLOUR
TRP0001AV	Black/Grey



UMBRELLA HOLDER

Includes an umbrella holder to fix to the Volta's universal base unit.



IDEAL FOR ICART BAGS

Designed to be the perfect fit for heavy cart bags, the Volta is a superb fit for all iCart bags.

COMPLETE CONTROL

The 360° rotating wheel offers superb manoeuvrability and control. A hand operated front wheel lock can be used for when moving on rougher terrain.



ICART ONE

LIGHTWEIGHT & STURDY

The original iCart, feature packed, lightweight design and advanced folding system means it's easy to operate and transport.

The iCart one comes with a drinks holder, multi feature soft touch handle and scorecard holder, quick release wheels, strong adjustable bag straps, easy to use foot brake and extensive parts back up. An umbrella holder is included using an integrated base unit.

CODE	COLOUR
TRP0001NGYB	Grey/ Black
TRP0001NGBY	Black/Grey



TRANSPORT EASILY

Weighing in at 7.35kg and at 80cm x 32.5cm x 43.5cm when folded, iCart One is the perfect travel partner.



UMBRELLA HOLDER

Includes an umbrella holder to fix to the One's universal base unit.



FEATURE RICH COMPONENTS

Adjustable handle and straps to suit player height with a universal umbrella holder included.



ICART EVO

SUPER COMPACT & LIGHTWEIGHT

The smallest iCart in the range, the Evo folds down quickly to a compact size, with removable wheels. Perfect for golfers with limited boot space.

The iCart Evo comes with a drinks holder, multi feature soft touch handle and scorecard holder, quick release wheels, strong adjustable bag straps, easy to use foot brake and extensive parts back up. An umbrella holder is included using an integrated base unit.

CODE	COLOUR
TRP00021GYB	Grey/ Black
TRP00021BGY	Black/Grey



SUPER LIGHT AND COMPACT

Weighing in at 7.5kg and at 57cm x 44cm x 36cm when folded, iCart Evo is the perfect travel partner.



UMBRELLA HOLDER

Includes an umbrella holder to fix to the Evo's universal base unit.



FEATURE RICH DASHBOARD

With ball holders, drinks holder, valuables case and an umbrella holder the Evo has everything users need for organising their assets,

SMALL, BUT STURDY

Lightweight aluminium frame with quick release wheels that can be easily removed for compact storage.



ICART GO

LIGHTWEIGHT DESIGN

Our entry level iCart, packed with great functionality & fast fold system for easy transport and operation.

The iCart Go comes with a base unit for an umbrella holder, drinks holder, multi feature soft touch handle and scorecard holder, quick release wheels, strong adjustable bag straps, easy to use foot brake and extensive parts back up.

CODE	COLOUR
TRP0017GYB	Grey/ Black

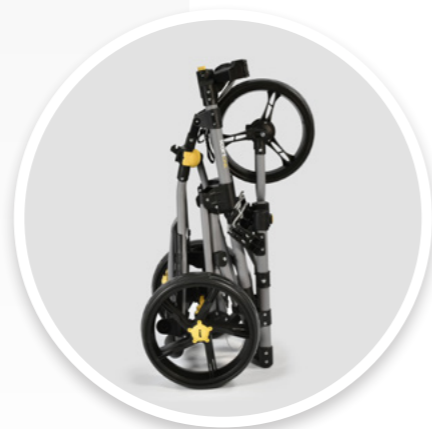

FAST FOLDING, EASY TO USE

Weighing in at 7.5kg and at 78cm x 33.5cm x 42cm when folded, iCart Go is the perfect travel partner.



FEATURE RICH DASHBOARD

The Go comes with strong adjustable bag straps and a one-click folding system activated by a quick release button.



STURDY CONSTRUCTION

Lightweight aluminium frame with quick release wheels that can be easily removed for storage.

ICART STORAGE BAG

SAFE STORAGE FOR TROLLEYS

Great for storing your iCart, keeping it clean and dust-free or alternatively if the wheels are muddy and wet this bag keeps car boots clean and dry.

CODE	TRADE	RRP
BA90B	€19.99	€39.99



DURABLE CONSTRUCTION

Hard-wearing canvas fabric and unique iCart durable rubber zippers make the storage ideal for housing trolleys when not on the course.



STRONG & STURDY

Strong carry handles make the iCart Storage Bag the ideal partner for an iCart trolley.



EASY ACCESS

The front side unzips and opens completely for easy access, which also allows for cleaning and removing of grass and mud.



MASTERS GOLF SUPERLIGHT 7

LIGHTWEIGHT COMPACT TROLLEY BAG

Our smallest trolley bag, compact, feature rich and loaded with storage. Perfect for carrying selected clubs for short rounds or for golfers who just want a lighter trolley bag without compromising on storage or features.

CODE	COLOUR	TRADE	RRP
BGMT1000	Black/ Grey/ Red	€50.49	€99.99
BGMT1001	Navy/ Grey/ Red	€50.49	€99.99
BGMT1002	Grey/ Black/ White	€50.49	€99.99



4-WAY DIVIDER TOP

Ideal for club organisation, the 4-way divider top also comes with a rubberised carry handle.



LIGHTWEIGHT, BUT DURABLE

4-way full length divider with integrated carry handle, 2x large apparel side pockets, 5x equipment storage pockets, 1x insulated cooler pocket.



THE IDEAL TROLLEY PARTNER

The universal trolley base works with most trolley brands and a superb fit for all Masters Golf trolleys.



MASTERS GOLF SL650 VELO

SUPER LIGHTWEIGHT HALF-SET BAG

Our most popular half-set bag returns with a fresh design and new colours for 2022. Perfect for carrying selected clubs for short rounds or through the winter months during course trolley bans.

For x1 unit and x8:

CODE	COLOUR
BGMS6504NW	Navy/ White
BGMS6504BG	Black/Grey
BGMS6504GG	Grey/ Light Grey
BGMS6504GG	Grey/ Acid Yellow

For Single Boxed and x8:

CODE	COLOUR
BGMS6504SNW	Navy/ White
BGMS6504SBG	Black/Grey
BGMS6504SGG	Grey/ Light Grey
BGMS6504SGY	Grey/ Acid Yellow



TRIED & TESTED

The SL650 has been a course favourite for many due to its compact size and lightweight structure.



4-WAY DIVIDER WITH HANDLE

A well proportioned 4-way divider ideal for taking half-sets around the course



WELL EQUIPPED

Carry handle, large apparel side pockets, front equipment storage pocket and side soft pocket for valuables.



MASTERS GOLF SL500 VELO

SUPER LIGHTWEIGHT HALF-SET BAG

This bag is perfect for selected clubs, half sets, or winter golf when courses have banned the use of trolleys. It features a dual carry strap taking the weight onto both shoulders. Other features include 'Activ-8' stand, ball pouch, and a handy integrated rain hood.

CODE	COLOUR
BGMS503BGY	Black/Grey
BGMS503GYG	Grey/Yellow



INTEGRATED BAG HOOD

The SL500 integrated bag hood is essential for protecting clubs whether on the course, or in storage.



WELL EQUIPPED

Despite its reduced size, the SL500 is well equipped with dual padded strap, grab handle, generous shoulder padding and ball net for easy access.

MASTERS GOLF 5 SERIES

3-WHEEL PUSH TROLLEY

A best seller and a popular trolley on the course. The 5 Series 3 wheel push cart has a sturdy yet lightweight aluminium frame capable of carrying the heaviest of bags whilst still remaining manoeuvrable. Features a base unit for an umbrella holder and accessory pouch for storing balls.

CODE	QTY	COLOUR
TRP0006B	2*	Black
TRP0006W	2*	White

*Sold in boxed outers of 2



UNIVERSAL BASE UNIT

The 3 Series comes with a universal base unit to dock the Masters Golf Umbrella Holder (TRA0016 sold separately).



FAST FOLDING SYSTEM

Compact when collapsed making transportation and storage easy. The lightweight aluminium frame folds down in seconds.



ADJUSTABLE HEIGHT

Making it easy to store in the garage or the boot of your car. Also features a drinks holder to store your water bottle for quick access when playing.



STURDY BASE

The 5 Series can support the shape and weight of any cart bag and glide easily over most terrain.



MASTERS GOLF 5 SERIES

2-WHEEL COMPACT PULL TROLLEY

Tried and tested. The 5 Series pull cart has a sturdy yet lightweight aluminium frame and collapses down for ease of transport & storage. Also features a universal base fitment to fit most golf bag designs.

CODE	COLOUR
TRP0007S	Silver



SERIOUSLY COMPACT

The lightweight aluminium frame (at just 2.7kg) folds into 58 x 31 x 30cm making this pull trolley one of the smallest on the market when folded.



ADJUSTABLE HEIGHT

The handle height and bag support bracket are both adjustable, meaning that users can adjust to their desired needs.



FAST FOLDING

The 5 Series Compact easily folds away to take up minimal space for the journey to and from the course with easier manoeuvrability.

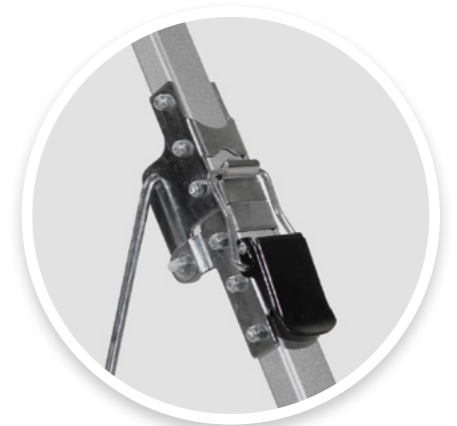



RENTAL TROLLEY DEAL

TRP0015B

Refresh your rental trolley stock with a great offer on bulk purchasing. Save up to 20% when ordering 24 units.

The Masters Golf Three Wheel Rental Cart comes with a strong-frame, durable handle grips and removable bag bracket capable of carrying heavy cart bags.

Kaktus wheel compatible with rental trolley



CODE

TRP0015B

**Minimum quantity/ order multiple x2*

Replacement Top Bag Bracket

TRP0015B



MASTERS GOLF 1 SERIES

2-WHEEL PUSH TROLLEY

The Masters Golf 1 Series Trolley has two wheels and a simple frame, making it ultra light. It's compact when folded down, clicks together in seconds and is easy to manoeuvre.

CODE	QTY
TRSIN13B	1
TRP0013B	4*

*Sold in boxed outers of 4



MASTERS GOLF 3 SERIES

2-WHEEL COMPACT PULL TROLLEY

Tried and tested. The 3 Series pull cart has a sturdy yet lightweight aluminium frame and collapses down for ease of transport & storage. Also features a universal base fitment to fit most golf bag designs.

CODE
TRP0011B

*Minimum quantity/ order multiple x2



MASTERS GOLF 5 SERIES

JUNIOR 3-WHEEL PUSH TROLLEY

The 5 Series Junior 3 Wheel Cart is an ideal starter for aspiring players. The adjustable handle ensures it will fit from tyke to teen to make pushing it a breeze. Multi-feature scorecard holder and quick release wheels make this a course favourite.

CODE

TRP00125B

**Sold in boxed outers of 2*



COMFORTABLE & ADJUSTABLE

Two-handed soft touch handle and height adjustable handle and bag bracket, perfect for Junior players.



INTEGRATED BRAKE PEDAL

A quick release wheel and easy to function brake pedal ensures the 5 series is operated safely and securely.



STAND BAG SUPPORT

Bag holder is suitable for both trolley and stand bags with mouldings designed to accept stand bag mechanisms.



MASTERS GOLF 1 SERIES

JUNIOR 2-WHEEL PUSH TROLLEY

The 1 Series Junior Trolley manoeuvres comfortably thanks to its ergonomic handle. The unique design of the back bracket allows it to carry either a stand or cart bag with comfort.

CODE

TRP0014B

**Sold in boxed outers of 2*



SUPER LIGHTWEIGHT

Weighing in at only 2.7kg, the super lightweight frame is ideal for Juniors.

HEIGHT ADJUSTABLE HANDLE

An adjustable height handle and adjustable stand bag friendly bag bracket allow you to find the best size for ease of use.



STAND BAG SUPPORT

Bag holder is suitable for both trolley and stand bags with mouldings designed to accept stand bag mechanisms.

MKIDS 3-WHEEL

COMPACT AND LIGHTWEIGHT PUSH TROLLEY

Designed specifically with Junior players in mind, the MK Golf trolley is packed with great functionality & also lightweight with a simple folding system for easy transport and operation.

The MK Golf trolley comes with a drinks holder, multi feature soft touch handle and scorecard holder, quick release wheels, strong adjustable bag straps, easy to use foot brake and extensive parts back up.

CODE	COLOUR
TRP00122A	White



FAST FOLDING SYSTEM

Compact when collapsed making transportation and storage easy. The lightweight aluminium frame folds down in seconds.



FEATURE RICH DASHBOARD

With soft grip handle, drinks holder, valuables case and dock for an umbrella holder the trolley has everything users need for organising their assets,



FAST FOLDING SYSTEM

Compact when collapsed making transportation and storage easy. The lightweight aluminium frame folds down in seconds.

LEATHERETTE BALL BAG

BALL STORAGE

Perfect for carrying your practice balls to and from the course. Made from a leatherette material, it has tough, smooth-touch zips and comfortable carry handles.

CODE

BG11B



LEATHERETTE SHOE BAG

FOOTWEAR PROTECTION

With long zips, carry strap and durable construction this is a great shoe-care accessory. It features air vents on the sides and bottom to allow moisture to escape, has a soft leather-like feel, and a zipped inner pocket.

CODE

BG23B



SEAFORTH SLICKER

UNRIVALLED PROTECTION

Using the same patented technology as the original Seaforth Rain Hood, the Seaforth Slicker is an extended version of the hood that covers the whole golf bag. The Slicker splits down the front allowing the golfer to simply wrap the Slicker around the bag.

CODE

BAUSSL3



STORMMASTER XRP

WET WEATHER PROTECTION

Full length bag cover, made with a lightweight and durable water proof outer shell. Universal fitment and designed to work most trolley, stand and carry bags. Elasticated hood offers easy access to clubs when on the course.

CODE

BA14B



RAIN WEDGE

EQUIPMENT PROTECTION

A high-tech, sturdy, lightweight cover the Rain Wedge uses the latest outdoor gear technology. It clips and straps the system to secure the rain wedge to your bag and it has a weighted front keeping the cover down.

CODE	QTY
BARW01	1



2-IN-1 BAG HOOD & TOWEL

DUAL PURPOSE PROTECTION

The TourDri 2-in-1 Bag Hood & Towel is a waterproof cover on one side and a super absorbent towel on the other, taking care of protecting and cleaning your golf equipment.

CODE
BA06B



SEAFORTH RAIN HOOD

ULTIMATE RAIN PROTECTION

The Seaforth Rain Hood is the waterproof rain cover preferred by tour professionals around the world. Darrell Survey results show that over 90% of PGA and LPGA players use the Seaforth Rain Hood.

CODE

BAUSRC3



RAIN HOOD WITH ZIP

EQUIPMENT PROTECTION

The elasticated fitting allows it to fit most bags, and the zipped access means you can get to your clubs without having to take it off again. It also features a shaped hole to retain your bag strap.

CODE

BA05B



CARABINER CONNECTORS

IDEAL FOR EQUIPMENT ACCESS

A non-locking carabiner clip with a sprung swinging gate that can be opened to insert or remove an accessory to your golf bag. The gate snaps shut under the springs pressure making this a superb universal connector.

CODE

BA07S

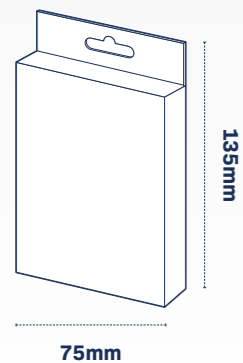

TROLLEY STRAPS

2x HEAVYWEIGHT WEBBED STRAPS

These super strong handy webbing straps have many uses but are mainly used to secure the golf bag to the trolley. They feature durable quick release clips and can easily be adjusted to the desired length.

CODE

ZDGA0102

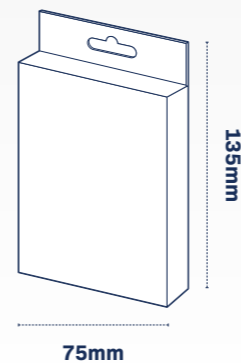

TROLLEY ELASTICS

2x FLEXIBLE STRAPS

These strong, handy elastics have many uses but are mainly used to secure your golf bag to your golf trolley. They fit all size bags and come complete with clips for connection.

CODE

ZDGA0100

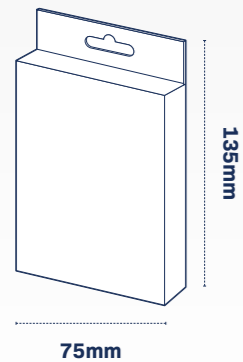

BAG TUBES

BAG ORGANISATION

Acting as full length dividers, slot them into each divider in your golf bag to maximise club space.

CODE

BA040



TROLLEY WHEEL COVERS

KEEPS DIRT AWAY

The Trolley Wheel Covers are used to stop dirt, grass and leaves being transferred to your clothes, equipment or car boot. They are fully washable and fit any size trolley wheels.

CODE

GA097



MASTERS GOLF

SCORECARD HOLDER

FOR TROLLEYS

The Scorecard Holder clips onto the handle bar of your trolley allowing you to carry a scorecard, pencil, balls and tees. The scorecard is protected from the rain and wind by a hinged storm cover.

CODE

TRA0010



MASTERS GOLF

TRI-FOLD TOWEL

WITH BAG CLIP

Allows you to keep your equipment clean and free from dirt – an essential part in any round. It features the unique addition of a club face cleaner patch.

CODE

BA00B



MASTERS GOLF

UMBRELLA HOLDER

UNIVERSAL FITMENT

The universal attachment fits all Masters Golf and iCart trolleys where the attachment is available on the handle.

CODE

TRA0016



MASTERS GOLF

UMBRELLAS

09

TOURDRI

UV RESISTANT CLEAR PANEL UMBRELLAS

A course favourite. The TourDri is super durable 32 inch golf umbrella, featuring a strong frame, pressure releasing vents, soft grip handle, rubber tip and auto opening mechanism. Usable all year round, the UV resistant inner lining also offers great protection from the sun.

CODE	COLOUR
UMCU311	Grey / 3 Clear Panels
UMCU312	Navy / 3 Clear Panels



UV RESISTANT LINING

Designed with a UV resistant inner lining which offers great protection from the sun.



CLEAR PANELS

Ideal for visibility when mounted on a trolley during showers.



COMFORT GRIP

All umbrellas feature a comfort grip handle for a secure hold.



TOURDRI

UV RESISTANT CLASSIC STYLE UMBRELLAS

A course favourite. The TourDri is super durable 32 inch golf umbrella, featuring a strong frame, pressure releasing vents, soft grip handle, rubber tip and auto opening mechanism.

The TourDri umbrellas are usable all year round, they feature UV resistant inner lining also offers great protection from the sun.

CODE	COLOUR
UMCU305	Jet Black/White
UMCU306	Navy/White
UMCU307	Navy
UMCU309	Jet Black
UMCU313	Arctic White



COMFORT GRIP

All umbrellas feature a comfort grip handle for a secure hold.



UV RESISTANT LINING

Designed with a UV resistant inner lining which offers great protection from the sun.



TOURDRI

COLOUR BURST RANGE

A course favourite. The TourDri is super durable 32 inch golf umbrella, featuring a strong frame, pressure releasing vents, soft grip handle, rubber tip and auto opening mechanism. Usuable all year round, the UV resistant inner lining also offers great protection from the sun.



UV RESISTANT LINING

Designed with a UV resistant inner lining which offers great protection from the sun.

CODE	COLOUR
UMCU300	Storm Grey/Jet Black
UMCU301	Electric Blue/Jet Black
UMCU302	Poppy Red/Jet Black
UMCU304	Lime Punch/Jet Black
UMCU320	Hot Coral/Jet Black
UMCU321	Mint Leaf/Jet Black



COMFORT GRIP

All umbrellas feature a comfort grip handle for a secure hold.



DRIVING RANGE
PRACTICE STUDIO
JUNIOR GOLF
HEADCOVERS
CLUBS & CLUB SETS
UMBRELLAS
BAGS & TROLLEYS
FLIGHT COVERS
GOLF BALLS & RETRIEVERS
GLOVES
CONSUMABLES
CLEATS
ACCESSORIES
TEES

CLUBS & CLUB SETS



GX1 RELOADED

DESIGNED WITH PLAYABILITY IN MIND, THE GX1 RANGE ARE GREAT PACKAGE SETS FOR THE CASUAL GOLFER OR A NEW STARTER.

GX1 Clubs

The clubs have been specifically designed to offer good control, distance and flight. Naturally forgiving, the clubs also help build player confidence and skill level. Available in mens and womens sets with graphite or steel shaft options.

GX1 Bags

The GX1 club sets come with matching and well specified, light weight stand or trolley bags with plenty of storage and easy to handle whether being carried or on a trolley.

CAVITY BACK IRONS

The cavity behind the centre of the club face provides more perimeter weighting and makes these irons easier to hit.



OVER SIZE HEADS

More forgiving on those off-centre shots these club heads help improve confidence in less experienced players.

GUIDE TO GX1 SETS

SET	DEXTERITY	5	6	7	8	9	PW	SW	DRIVER	FAIRWAY	HYBRID	PUTTER
Gents Package Sets	RH / LH	✓	✓	✓	✓	✓	✓	✓	✓	✓	✓	✓
Gents Half Set	RH / LH			✓		✓		✓	✓		✓	✓
Ladies Package Set	RH / LH		✓	✓	✓	✓	✓	✓	✓	✓	✓	✓
Ladies Half Set	RH / LH			✓		✓		✓	✓		✓	✓

GX1 GENTS CLUBPACK

WITH STAND BAG

The GX1 Reloaded Club Set returns for 2023 with an updated design and lightweight stand bag. Ideal for higher handicappers and new starters to the game by offering forgiveness in every shot.

- Irons included: 5, 6, 7, 8, 9, P, S
- Woods included: Driver, Fairway, Hybrid
- Traditional mallet putter
- Stainless steel iron heads
- Graphite or Steel shafts
- Matching head covers
- Lightweight bag, with 14-way divider
- Front cool pocket and 2x valuable soft pocket

CODE	DEXTERITY	SHAFT
CP0155	Right-hand	Graphite
CP0156	Right-hand	Steel
CP0157	Left-hand	Graphite
CP0158	Left-hand	Steel



SUPER LIGHTWEIGHT BAG

A superb stand bag that comes with a 6-way full length divider and padded strap.



WOOD HEADCOVERS

A set of 3x fantastic wood headcovers for keeping clubs protected during transit or while out on the course.



BAGS OF STORAGE

An integrated cool pocket, 2x soft pockets, front ball pocket and 2x large equipment side pockets make the GX1 trolley bag ideal for all rounds.



10.5° DRIVER

15° FAIRWAY WOOD

24° HYBRID WOOD

GX1 GENTS CLUBPACK

WITH TROLLEY BAG

The GX1 Reloaded Club Set returns with an updated design and lightweight trolley bag. Ideal for higher handicappers and new starters to the game by offering forgiveness in every shot.

- Irons included: 5, 6, 7, 8, 9, P, S
- Woods included: Driver, Fairway, Hybrid
- Traditional mallet putter
- Stainless steel iron heads & graphite shafts
- Matching head covers
- Lightweight bag, with 14-way divider
- Front cool pocket and 2x valuable soft pocket

CODE	DEXTERITY
CP0150T	Right-hand



WOOD HEADCOVERS

A set of 3x fantastic wood headcovers for keeping clubs protected during transit or while out on the course.



SUPER LIGHTWEIGHT BAG

A superb trolley bag that comes with a 14-way full length divider and 3x integrated carry handles.



10.5° DRIVER

15° FAIRWAY WOOD

24° HYBRID WOOD



BAGS OF STORAGE

An integrated cool pocket, 2x soft pockets, front ball pocket and 2x large equipment side pockets make the GX1 trolley bag ideal for all rounds.



GX1 GENTS HALF SET

WITH 6.5" STAND BAG

The GX1 Reloaded Half Set is ideal for higher handicappers and new starters to the game by offering forgiveness in every shot whilst providing the essential clubs for casual play.

- Irons included: 7, 9, SW
- Woods included: Driver, Hybrid
- Traditional mallet putter
- Stainless steel iron heads & graphite shafts
- Matching headcovers
- 6.5" lightweight stand bag, with 4-way divider

CODE	DEXTERITY	SHAFT
CP0165	Right-hand	Graphite
CP0166	Right-hand	Steel
CP0167	Left-hand	Graphite
CP0168	Left-hand	Steel



STORAGE ESSENTIALS

Though small and lightweight. The half set bag features plenty of storage potential, with five integrated zippered pockets.



SUPER LIGHTWEIGHT BAG

A superb 6.5" stand bag that comes with a 4-way full length divider and padded strap.

ESSENTIAL CLUBS

The set includes a traditional mallet putter and Irons 7, 9, SW – the ideal half-set combination when paired with a Driver and Hybrid wood.



10.5° DRIVER

24° HYBRID WOOD

GX1 LADIES CLUBPACK

WITH TROLLEY BAG

The GX1 Reloaded Club Set returns with an updated design and lightweight trolley bag. Ideal for higher handicappers and new starters to the game by offering forgiveness in every shot.

- Irons included: 5, 6, 7, 8, 9, P, S
- Woods included: Driver, Fairway, Hybrid
- Traditional mallet putter
- Stainless steel iron heads & graphite shafts
- Matching head covers
- Lightweight bag, with 14-way divider
- Front cool pocket and 2x valuable soft pocket

CODE	DEXTERITY
CP0159	Right-hand
CP0160	Left-hand



WOOD HEADCOVERS

A set of 3x fantastic wood headcovers for keeping clubs protected during transit or while out on the course.



BAGS OF STORAGE

An integrated cool pocket, 2x soft pockets, front ball pocket and 2x large equipment side pockets make the GX1 trolley bag ideal for all rounds.



10.5° DRIVER

15° FAIRWAY WOOD

24° HYBRID WOOD



SUPER LIGHTWEIGHT BAG

A superb trolley bag that comes with a 14-way full length divider and carry strap.



GX1 LADIES HALF SET

WITH 8.5" TROLLEY BAG

The GX1 Reloaded Half Set is ideal for higher handicappers and new starters to the game by offering forgiveness in every shot whilst providing the essential clubs for casual play.

- Irons included: 7, 9, SW
- Woods included: Driver, Hybrid
- Traditional mallet putter
- Stainless steel iron heads & graphite shafts
- Matching headcovers
- 8.5" lightweight trolley bag, with 4-way divider

CODE	DEXTERITY	SHAFT
CP0170	Right-hand	Graphite
CP0171	Left-hand	Graphite



BAGS OF STORAGE

An integrated cool pocket, 2x soft pockets, front ball pocket and 2x large equipment side pockets make the GX1 trolley bag ideal for all rounds.



10.5° DRIVER

24° HYBRID WOOD



SUPER LIGHTWEIGHT BAG

A superb trolley bag that comes with a 14-way full length divider and carry strap.

ESSENTIAL CLUBS

The set includes a traditional mallet putter and Irons 7, 9, SW – the ideal half-set combination when paired with a Driver and Hybrid wood.



GX1 CLUBS

GENTS OPEN STOCK

The GX1 Reloaded open stock range offers a chance to either top-up your half set or simply offer individual clubs for high handicappers and new starters to the game.

IRONS

CODE	DESCRIPTION	SHAFT
IGX2R005	5 Iron Rh	Graphite
IGX2R006	6 Iron Rh	Graphite
IGX2R007	7 Iron Rh	Graphite
IGX2R008	8 Iron Rh	Graphite
IGX2R009	9 Iron Rh	Graphite
IGX2R00P	PW Iron Rh	Graphite
IGX2R00S	SW Iron Rh	Graphite
IGX2R015	5 Iron Rh	Steel
IGX2R016	6 Iron Rh	Steel
IGX2R017	7 Iron Rh	Steel
IGX2R018	8 Iron Rh	Steel
IGX2R019	9 Iron Rh	Steel
IGX2R01P	PW Iron Rh	Steel
IGX2R01S	SW Iron Rh	Steel

WOODS

CODE	DESCRIPTION	SHAFT
WGX2R001	Driver RH	Graphite
WGX2R003	Fairway Wood RH	Graphite
IGX2R004	Hybrid RH	Graphite
WGX2L001	Driver LH	Graphite
WGX2L003	Fairway Wood LH	Graphite
IGX2L004	Hybrid LH	Graphite

PUTTERS

CODE	DESCRIPTION	SHAFT
PU080	Putter RH	Steel
PU081	Putter LH	Steel



Gents 7 Iron

24° Gents Hybrid

15° Gents Fairway Wood

10.5° Gents Driver



Gents Grip & Graphite Shaft



Gents Grip & Steel Shaft

GX1 CLUBS

LADIES OPEN STOCK

The GX1 Reloaded open stock range offers a chance to either top-up your half set or simply offer individual clubs for high handicappers and new starters to the game.

IRONS

CODE	DESCRIPTION	SHAFT
IGX2R027	7 Iron RH	Graphite
IGX2R028	8 Iron RH	Graphite
IGX2R029	9 Iron RH	Graphite
IGX2R02P	PW Iron RH	Graphite
IGX2R02S	SW Iron RH	Graphite
IGX2L027	7 Iron RH	Graphite
IGX2L02S	SW Iron RH	Graphite

WOODS

CODE	DESCRIPTION	SHAFT
WGX2R021	Driver RH	Graphite
WGX2R023	Fairway Wood RH	Graphite
IGX2R024	Hybrid RH	Graphite
WGX2L023	Fairway Wood LH	Graphite

PUTTERS

CODE	DESCRIPTION	SHAFT
PU085	Putter RH	Steel
PU086	Putter LH	Steel



Ladies 7 Iron

24° Ladies Hybrid

15° Ladies Fairway Wood

10.5° Ladies Driver



Ladies Grip & Graphite Shaft

MASTERS GOLF JUNIOR HALF SET

MC-J530 6-PIECE SET

Attractively priced as an entry level set of junior clubs, the MCJ-530 clubs are perfect for introducing junior players to the game of golf.

Junior players will love the playability and ease of use the MC-J530 has. The stand bag also features a number of equipment pockets and ball net. The 6-piece set includes a Driver, headcover, 7/8 iron, 9/P iron, Putter and Standbag.

CODE	AGE RANGE	DEXTERITY
IJR535HSBR	Age 5-8	Right-hand
IJR539HSBS	Age 9-12	Right-hand



DRIVER HEADCOVER

A superb headcover to keep drivers free from scrapes and scratches while on course.



Age 9-12 Iron & Driver



PROGRESSIVE SIZING

The MC-J530 half set has been designed with two sizes with head size, shaft length and loft all considered.

Left: Age 5-8 Iron & Driver

MALLET PUTTER

A mallet style putter is ideal for junior players, giving control and stability through their stroke.



MASTERS GOLF PINZER P2

GENTS PERFORMANCE PUTTER

The Pinzer P2 benefits from a dark matte finish giving a premium look and feel as well as providing the perfect background for the white sightlines.

CODE	DEXTERITY
PU066	Right-hand

BLADE STYLE PUTTER

Players with an 'arc stroke' tend to perform better with the P2 blade style putter because of the weight distribution between the heel and toe.

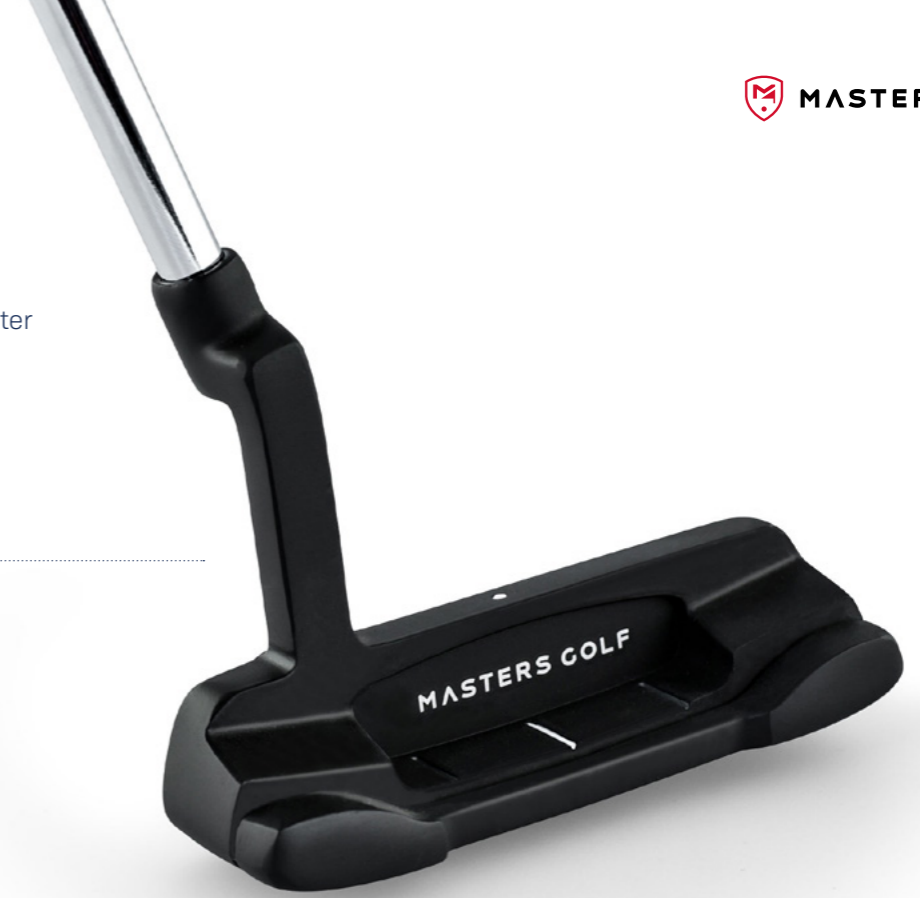

A MILLED STYLE FACE

Milled style pattern helps roll the ball smooth on impact across the entire face.



PISTOL PUTTER GRIP

Pistol style shape helps players hold the correct grip while putting.



- TEES
- ACCESSORIES
- CLEATS
- CONSUMABLES
- GLOVES
- GOLF BALLS & RETRIEVERS
- FLIGHT COVERS
- BAGS & TROLLEYS
- UMBRELLAS
- CLUBS & CLUB SETS
- HEADCOVERS
- JUNIOR GOLF
- PRACTICE STUDIO
- DRIVING RANGE

MASTERS GOLF PINZER P3

LADIES & GENTS PERFORMANCE PUTTER

The Pinzer P3 head features a simple matte finish in striking black or white. A milled style face promotes an improved impact, roll and control off the face.

CODE	DEXTERITY
PU067 - Gents (Black)	Right-hand
PU071 - Gents (Black)	Left-hand
PU070 - Ladies (White)	Right-hand

MALLET STYLE PUTTER

The mallet style shape of the P4 gives control and stability through the stroke, whilst providing more forgiveness on direction and roll due to the weight distribution.



A MILLED STYLE FACE

Milled style pattern helps roll the ball smooth on impact across the entire face.

PISTOL PUTTER GRIP

Pistol style shape helps players hold the correct grip while putting.



MASTERS GOLF PINZER P4

GENTS PERFORMANCE PUTTER

The Pinzer P4 benefits from a dark matte finish giving a premium look and feel as well as providing the perfect background for the white sightlines.

CODE	DEXTERITY
PU068	Right-hand

DEEP CAVITY

The deep insert on the P4 will help players put less backspin on putts, as well as feeling soft at impact.



MASTERS GOLF



PINZER P4

A MILLED STYLE FACE

Milled style pattern helps roll the ball smooth on impact across the entire face.



PISTOL PUTTER GRIP

Pistol style shape helps players hold the correct grip while putting.



MASTERS GOLF PINZER S1

GENTS PERFORMANCE PUTTER

The S1 has a modern mallet design featuring three white sightlines that stand out perfectly against the premium and striking matte black finish.

CODE	DEXTERITY
PU069	Right-hand

FORGIVING ON PUTTS

The dynamic shape and weight offers high resistance to twisting on impact, making the Pinzer S1 more forgiving on longer putts.



A MILLED STYLE FACE

Milled style pattern helps roll the ball smooth on impact across the entire face.



PISTOL PUTTER GRIP

Pistol style shape helps players hold the correct grip while putting.



MASTERS GOLF PINZER P1

CENTRE SHAFT PUTTER

A classic style suitable for either right or left handed players. Finished with a quality stainless steel shaft and premium matte black coating.

CODE	DEXTERITY
PU065	Dual

SUPPORT FOR NEW GOLFERS

Golfers who keep their eyes directly above the ball at address will benefit greatly from the P1 center-shafted putter.



A COURSE STALWART

Supported by a steel shaft and pistol style grip, the simple clean design of this putting stalwart makes the P1 a course favourite for many.

PISTOL PUTTER GRIP

Pistol style shape helps players hold the correct grip while putting.



MASTERS GOLF PINZER C1

GENTS PERFORMANCE CHIPPER

The versatile Pinzer C1 is an incredibly handy utility club. Designed to give greater control around the edge of the greens where a wedge or a putter just wont do.

CODE	DEXTERITY
CHP001	Right-hand

DEEP SOLE

A deeper sole design provides increased forgiveness to ensure players can get out of the harshest trouble around the greens.



IDEAL UTILITY CLUB

Designed for a putting style swing with an alignment aid to ensure you hit towards your intended target.

HYBRID GRIP

Hybrid tour style grip provides players with superb control and feel.



MASTERS GOLF PINZER C2

GENTS PERFORMANCE CHIPPER

The Pinzer C2 has been designed to provide short game consistency for the golfer that struggles around the greens with chip shots.

CODE	DEXTERITY
CHP002	Right-hand
CHP003	Left-hand

DEEP SOLE

The club has a low centre of gravity to promote consistency, plus has an alignment aid for easy targeting.



IDEAL UTILITY CLUB

The Pinzer C2 can be used with a putting style pendulum stroke which provides more chips to stay on their intended target lines.



HYBRID GRIP

Hybrid tour style grip provides players with superb control and feel.



HEADCOVERS



HEADKASE II COVERS

FITS MOST SIZE WOODS

These covers provide great protection for your irons and the elasticated finish keeps them in place. HeadKase products offer extreme protection coupled with the latest fabrics, ensuring a snug fit, long life and stylish looks. Numbered 4-SW.

CODE

WC80B

WC82B

IC70B



HEADKASE II IRON COVERS

TO FIT IRONS 4-SW

Headkase II Iron Covers are the ultimate in club protection and these feature a luxurious deep grain leatherette finish with fine detailed embroidered branding.

CODE

IC68B



PUTTER COVERS

TO FIT BLADE OR Mallet STYLE

Putter headcovers offering ultimate protection from rain and scratches while in your bag or in transit. Finished with a soft touch PU leatherette material and contrast piping.

CODE	STYLE
PC620B	Mallet
PC622B	Blade



HEADKASE PUTTER COVERS

HOME NATIONS FLAG DESIGNS

Masters Golf Headkase Flag Putter covers featuring the flags of England, Scotland, Wales and Ireland. An excellent putter cover for any patriotic golfer.

CODE	STYLE
PC17E	England
PC17I	Ireland
PC17S	Scotland
PC17W	Wales



NEOPRENE IRON COVERS

TO FIT IRONS 4-SW

These covers provide great protection for your irons and the elasticated finish keeps them in place. HeadKase products offer extreme protection coupled with the latest fabrics, ensuring a snug fit, long life and stylish looks. Numbered 4-SW.

CODE

IC34B



CASTLE BAY IRON COVERS

TO FIT IRONS 3-SW

The Castle Bay Iron Covers 3-SW keep irons safe from scratching and also protect against bashing about with other clubs while in your bag. Moulded one-piece patented design has no breakable parts and will not rip, tear or crack.

CODE

IC35CB





NOVELTY HEADCOVERS

LASCAR

High quality, plush headcovers that will protect your golf clubs with style. Made from super soft, high quality materials inside and out.

CODE	STYLE
WCL003	Owl
WCL004	Koala
WCL009	Rhino
WCL011	Monkey
WCL012	Tiger
WCL015	White Cow
WCL016	Bear
WCL017	Stag



JUNIOR GOLF

12

LITE PACKAGE SET

FOR PLAYER HEIGHT 43" TO 47"

MKids boxed half sets offer everything the young aspiring golfer needs to start their journey.

CODE	DEXTERITY
SETMK2R45	Right hand
SETMK2L45	Left hand

45"
115cm

5-piece set includes:

- Fairway metal wood
- 7 iron
- 9 iron
- SLA putter
- Stand bag



LITE PACKAGE SET

FOR PLAYER HEIGHT 47" TO 51"

MKids boxed half sets offer everything the young aspiring golfer needs to start their journey.

CODE	DEXTERITY
SETMK2R49	Right hand
SETMK2L49	Left hand

49"
125cm

6-piece set includes:

- Fairway metal wood
- 6 iron
- 8 iron
- Pitching wedge
- SLA putter
- Stand bag



LITE PACKAGE SET

FOR PLAYER HEIGHT 51" TO 55"

MKids boxed half sets offer everything the young aspiring golfer needs to start their journey.

CODE	DEXTERITY
SETMK2R53	Right hand
SETMK2L53	Left hand

53"
135cm

6-piece set includes:

- Fairway metal wood
- 6 iron
- 8 iron
- Pitching wedge
- SLA putter
- Stand bag



PRO PACKAGE SET

FOR PLAYER HEIGHT 55" TO 59"

MKids boxed half sets offer everything the young aspiring golfer needs to start their journey.

CODE	DEXTERITY
SETMK2R57	Right hand
SETMK2L57	Left hand

57"
145cm

6-piece set includes:

- Fairway metal wood
- 6 iron
- 8 iron
- Pitching wedge
- SLA putter
- Stand bag



PRO PACKAGE SET

FOR PLAYER HEIGHT 59" TO 63"

MKids boxed half sets offer everything the young aspiring golfer needs to start their journey.

CODE	DEXTERITY
SETMK2R61	Right hand
SETMK2L61	Left hand

61"
155cm

6-piece set includes:

- Fairway metal wood
- 6 iron
- 8 iron
- Pitching wedge
- SLA putter
- Stand bag



PRO PACKAGE SET

FOR PLAYER HEIGHT 63" TO 67"

MKids boxed half sets offer everything the young aspiring golfer needs to start their journey.

CODE	DEXTERITY
SETMK2R65	Right hand
SETMK2L65	Left hand

65"
165cm

6-piece set includes:

- Fairway metal wood
- 6 iron
- 8 iron
- Pitching wedge
- SLA putter
- Stand bag



MKIDS SLA PUTTER

AVAILABLE IN ALL PLAYER HEIGHTS

MKids Putter are designed to suit all young golfers. The SLA suits a 'slight arc' putting stroke and is beautifully designed featuring steel shafts and a proprietary MKLITE and MKPRO grip offering accuracy and stability.

R/H

CODE	SIZE
PMK2R45F	45"
PMK2R49F	49"
PMK2R53F	53"
PMK2R57F	57"
PMK2R61F	61"
PMK2R65F	65"

L/H

CODE	SIZE
PMK2L45F	45"
PMK2L49F	49"
PMK2L53F	53"
PMK2L57F	57"
PMK2L61F	61"
PMK2L65F	65"

Junior golfers who putt using a slight arc will benefit from the SLA putter as it will naturally match their motions during swing and impact.



Colour coordinated grips to compliment the full MKids age and height specific range.

MKIDS SQ2 PUTTER

AVAILABLE IN ALL PLAYER HEIGHTS

MKids Putters are designed to suit all young golfers. The SQ2 suits junior players who need support with their putting stroke and is beautifully designed featuring steel shafts and a proprietary coloured grips offering accuracy and stability.

CODE	SIZE
PMK2R45V	45"
PMK2R49V	49"
PMK2R53V	53"
PMK2R57V	57"
PMK2R61V	61"
PMK2R65V	65"



The mallet style shape gives control and stability for Junior players, whilst providing more forgiveness on direction and roll due to the weight distribution.



Colour coordinated grips to compliment the full MKids age and height specific range.



MKLITE STANDBAGS

PROGRESSIVE SIZES

MKids have used a lightweight, high denier material to ensure durability. A multiple pocket layout maximises storage space for all the essentials you need to carry around during your round.

To provide a comfortable carry MKids have provided a dual carry strap design that spreads the weight across your shoulders to reduce fatigue and injury.

CODE	SIZE	COLOUR
BGMK245	45"	Yellow
BGMK249	49"	Orange
BGMK253	53"	Red



MKPRO STANDBAGS

PROGRESSIVE SIZES

MKids have used a lightweight, high denier material to ensure durability. A multiple pocket layout maximises storage space for all the essentials you need to carry around during your round.

To provide a comfortable carry MKids have provided a dual carry strap design that spreads the weight across your shoulders to reduce fatigue and injury.

CODE	SIZE	COLOUR
BGMK257	57"	Green
BGMK261	61"	Blue
BGMK265	65"	Black



MKPRO TOUR BAG

PERFECT FIT FOR JUNIOR TROLLEYS

The MKPro Tour Bag is designed with a 14 club top divider and 8 zipped pockets, perfect for the young golfer to carry all required for a round of golf.

CODE

BGMK2T01



- 32" length, 2.0kg weight
- 8 equipment pockets
- Insulated 'cool' pocket
- Soft pocket for valuables
- Base cutaway to fit trolley
- 14-way divider top



INSULATED 'COOL' POCKET

Keep energised throughout your day. This cool pocket will allow you to keep your snacks and drinks cool whilst on the course.



14-WAY DIVIDER

14-way divider with two integrated carry handles for easy manoeuvring.



GENEROUS STORAGE

Equipped with a valuables soft pocket and large side pockets for equipment storage.

MKIDS 3-WHEEL

COMPACT AND LIGHTWEIGHT PUSH TROLLEY

Designed specifically with Junior players in mind, the MK Golf trolley is packed with great functionality & also lightweight with a simple folding system for easy transport and operation.

The MK Golf trolley comes with a drinks holder, multi feature soft touch handle and scorecard holder, quick release wheels, strong adjustable bag straps, easy to use foot brake and extensive parts back up.

CODE	COLOUR
TRP00122A	White



FAST FOLDING SYSTEM

Compact when collapsed making transportation and storage easy. The lightweight aluminium frame folds down in seconds.



FEATURE RICH DASHBOARD

With soft grip handle, drinks holder, valuables case and dock for an umbrella holder the trolley has everything users need for organising their assets,



FAST FOLDING SYSTEM

Compact when collapsed making transportation and storage easy. The lightweight aluminium frame folds down in seconds.

MKIDS JUNIOR GLOVE

PROGRESSIVE SIZING

Our MKids Golf gloves are available in four colour-coded sizes and feature a high tech water-resistant fabric for use all year round.

Junior L/H

CODE	SIZE	COLOUR
JUGL5WOS	S	Orange
JUGL6WRM	M	Red
JUGL7WGL	L	Green
JUGL8WLX	XL	Blue

Junior R/H

CODE	SIZE	COLOUR
JUGR5WOS	S	Orange
JUGR6WRM	M	Red
JUGR7WGL	L	Green
JUGR8WLX	XL	Blue



Additional patches on palm for extra grip and durability



Flexibility and increased breathability

Embossed rubber MK Logo

MKIDS HEADCOVERS

TO FIT MOST DRIVERS & WOODS

Made from a soft PU leatherette, these MKids headcovers offer junior golfers a premium looking headcover set ideal for protecting their clubs. The classic sock design compliments the MK range and gives players flexibility while changing clubs.

CODE	STYLE
WCMKD	Driver
WCMKF	Fairway
WCMKH	Hybrid



MKIDS GOLF

PRODUCT AVAILABILITY



PLAYER HEIGHT	D	F	H	5	6	7	8	9	P	S	SLA PUTT	SQ2 PUTT	4-CLUB BOX SET	5-CLUB BOX SET
45" 115cm	▪	▪	▪			▪		▪	▪	▪	▪▪	▪	▪▪	
49" 125cm	▪	▪	▪		▪	▪	▪	▪	▪	▪	▪▪	▪		▪▪
53" 135cm	▪▪	▪▪	▪▪	▪▪	▪▪	▪▪	▪▪	▪▪	▪▪	▪▪	▪▪	▪		▪▪



PLAYER HEIGHT	D	F	H	5	6	7	8	9	P	S	SLA PUTT	SQ2 PUTT	5-CLUB BOX SET
57" 145cm	▪▪	▪▪	▪▪	▪▪	▪▪	▪▪	▪▪	▪▪	▪▪	▪▪	▪▪	▪	▪▪
61" 155cm	▪	▪	▪	▪	▪	▪	▪	▪	▪	▪	▪▪	▪	▪▪
65" 165cm	▪	▪	▪	▪	▪	▪	▪	▪	▪	▪	▪▪	▪	▪▪

KEY:

- Right Hand Availability
- Left Hand Availability

PRACTICE STUDIO



CHIPPING NET

PRACTICE EQUIPMENT

The Leadbetter chipping net is the perfect way for players to practice and improve their short game. Easily assembled, the pop-up construction means the chipping net is ready to use in seconds and is suitable for indoor or outdoor use.

CODE

PEL0015

WHAT'S IN THE BOX?

- 1x Chipping Net
- Carry Case
- Stanchion support & pegs



CABRETTA GLOVE

LEGAL FOR PLAY

Premium Cabretta leather glove offering premium feel, fit & comfort whilst also visually assisting players to ensure a perfect grip every swing.

Legal for play as well as coming with a soft, smooth feel for a consistent fit, flexibility and increased breathability.

CODE

SIZE

PEL0001	S
PEL0002	M
PEL0003	M/L
PEL0004	L
PEL0005	XL



SWINGSETTER

FOR SWING IMPROVEMENT

The SwingSetter is the ultimate multi-sensory training aid using sound, sight & feel to instantly provide feedback on a player's swing. It doesn't just fix one particular fault, it simply and quickly gets right to the heart of the swing – grip, plane, tempo and release.

CODE

PEL0011

FEEL & HEAR THE RESULTS...

Provides instant visual and auditory feedback to the player on back swing and swing.



GOLF PRIDE® TRAINING GRIP

The exclusive SwingSetter grip ensures perfect grip placement and comes with the quality you'd expect from a Golf Pride® manufactured grip.



PUTTING BAR

PUTTING PRACTICE

This ergonomically shaped putting bar simply slides under the arms and allows the player to feel the connection between the triceps and chest helping the upper body move as a unit.

CODE

PEL0012



LIGHTWEIGHT & COLLAPSIBLE

Lightweight aluminium construction that collapses down for easy storage in a golf bag.



CREATES A NATURAL SWING

This ergonomically shaped putting bar simply slides under your arms and will provide feedback each swing.

DRIVING NET

INDOOR OR OUTDOOR PRACTICE

The Leadbetter driving net enables players to safely practice their tee shots and drives at home. Easily assembled and suitable for indoor or outdoor use, players can practice in their own space and on their own schedule.

CODE

PEL0017

WHAT'S IN THE BOX?

- 1x Driving Net: 350cm (w) 220cm (h) 145cm (d)
- Hanging target: 72.5cm (w) x 104cm (h)
- Carry Case
- Stanchion support & pegs



SWING SOLUTION

SWING PRACTICE

The Leadbetter Swing Solution features alignment aids to help players visualize a target line for their swing. The feedback rods also allow them to establish a proper swing path for hitting longer and straighter. A great tool for coaching, for use on the range or at home with practice balls.

CODE

PEL0021

WHAT'S IN THE BOX?

- 1x Swing Solution plate
- 4x Foam Power Rods

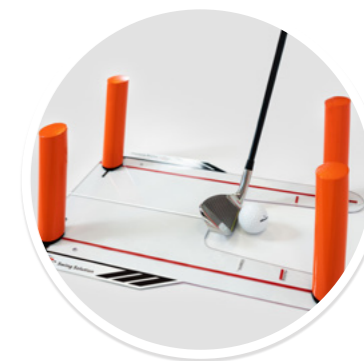

ALIGNMENT AIDS

The Leadbetter Swing Solution features alignment aids to help players visualize a target line for their swing.



FOAM POWER RODS

Establish a proper swing path for hitting longer and straighter by using the foam power rods for physical feedback.



SWING SPEED TRAINER

FOR WARM-UPS & MUSCLE MEMORY

The OverSpeed Swing Trainer is designed to improve your swing speed while providing a core muscle workout. This increases performance and improves sequencing in the golf swing to give extra distance off the tee.

CODE	WEIGHT
PE220	250g
PE222	290g
PE224	330g



DRILL STIX

FOR SWING ALIGNMENT PRACTICE

Simple to use and very lightweight, the Drill Stix improve shot accuracy, balance and short game confidence resulting in lower scores. Place one stick just behind your golf ball and the other in front of your feet to ensure that your feet, hips and shoulders are aligned with your target.

CODE	WEIGHT
PE136LG	Green
PE136O	Orange
PE136Y	Yellow
PE136P	Pink
PE136R	Red
PE136W	White



TEMPO TRAINER

PERFECT YOUR SWING

The Masters Golf Swing Tempo Trainer helps to perfect your swing, tempo and balance whilst strengthening your golf muscles. The Tempo Trainer is perfect as a low impact warm-up before a round of golf or at home to keep up tempo and rhythm.

CODE	QTY
PE172	1



SWING & GRIP TRAINER

FOR WARM-UPS & MUSCLE MEMORY

The Warm Up swing & Grip Trainer will teach the muscles used in the golf swing to memorise the action, producing a natural movement and improving game consistency whilst at the same time reducing the risk of injury.

CODE
PE042



BACKYARD GOLF SET

SETUP A MINI-COURSE

Bring the golf course to your garden and improve your game by practising in your own time. Change your game up each time but set up your own golfing hole.

CODE

PE057



PUTT RETURNER

PUTTING PRACTICE

The Putt Returner is a great little gadget that automatically pings your golf balls back to you when you hit them on target. Great for improving your accuracy and can be used at home or in the office.

CODE

PE090



HAZARD PUTTING MAT

PUTTING PRACTICE

The Masters Golf Deluxe Hazard Putting Mat will help you lower your score dramatically. It is made from specially selected synthetic matting to ensure consistent roll and accuracy of the ball. It is raised at one end with a hole to give a real 'on the green' feel. It also features a bunker and a water hazard and will return the ball.

Size: 200cm x 33cm

CODE

PE076



RETURN PUTTING MAT

PUTTING PRACTICE

This Deluxe Return Putting Mat is great value for money and will allow for golf practice putting for hours on end in the comfort of your own home. You will get a real feel as it slopes up at the end so you need to give it that little bit more speed to get it up to the hole.

Size: 200cm x 25cm

CODE

PE074



DUAL SPEED PUTTING MAT

PUTTING PRACTICE

The Dual Speed Putting Mat allows you to practice wherever and whenever you want. Featuring a unique 'Faster - Slower' surface and a moveable putting cup.

Size: 242cm x 36cm

CODE

PE110



PUTTING MAT

PUTTING PRACTICE

Made from specially selected synthetic matting to ensure consistent roll and accuracy of the ball. It is raised at on end with a hole to give a real 'on the green' feel.

Size: 198cm x 30.5cm

CODE

PE070



PUTTING CUP GREEN BAIZE

PUTTING PRACTICE

Whether at home or in the office it is great for improving your putting. Simply place it on the ground at the desired distance and putt! It has hinged side plates which let the ball roll into the cup and stop it escaping once inside.

CODE

PE023



CHIP & DRIVE MAT

GREAT FOR SWING PRACTICE

A practice quality mat that gives a realistic feel of grass and can be transported with ease allowing it to be used anywhere for practice.

Size: 61cm x 31.5cm

CODE

PE121

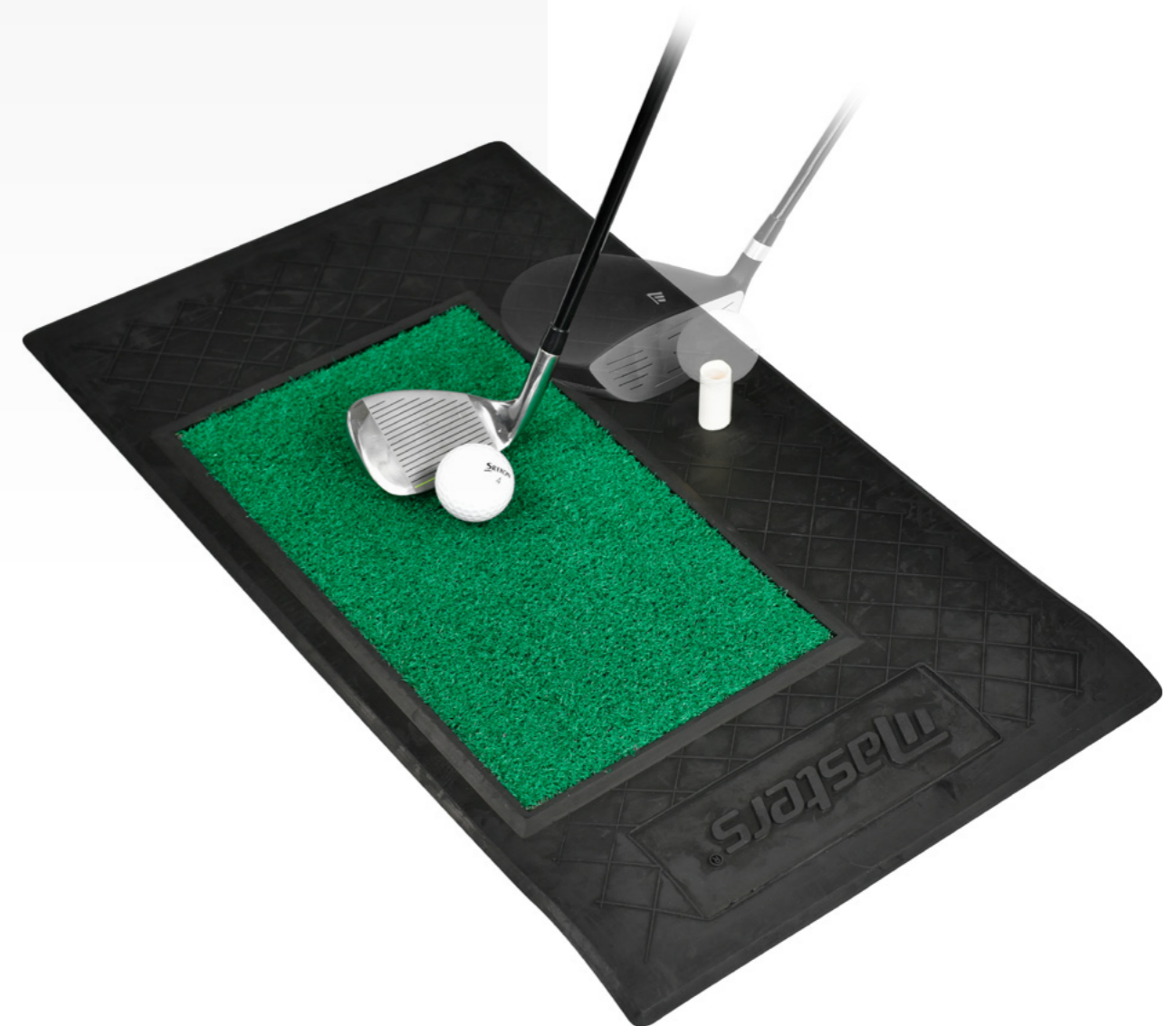

WINTER MAT

FOR USE ON WET GROUND

Allows for practice of wood or iron shots in places where you don't want to take a divot or for use in winter.

CODE	QTY
PE129	1



 **MASTERS GOLF**

LASER PUTTING TRAINER

PUTTING PRACTICE

Works great for both right and left-handed golfers. Easily attaches to the shaft of your putter giving a laser guideline check of your putting line.

CODE
ZDPE180



 **MASTERS GOLF**

SMASH BAG

SWING, TEMPO & MUSCLE MEMORY

Simply fill the bag with clothes or towels and strike the bag aiming at the target. The Smash Bag crushes down flat when not in use and features a handle for repositioning and carrying.

CODE
PE170B



 **MASTERS GOLF**

8x LEAD WEIGHTS

STRIPS FOR FINE TUNING SWINGS

Use these lead weight strips to experiment with the swing weight of your clubs. Each one has a self-adhesive backing and weights 3 grams, which is the equivalent of one swingweight.

CODE
ZDGA0200

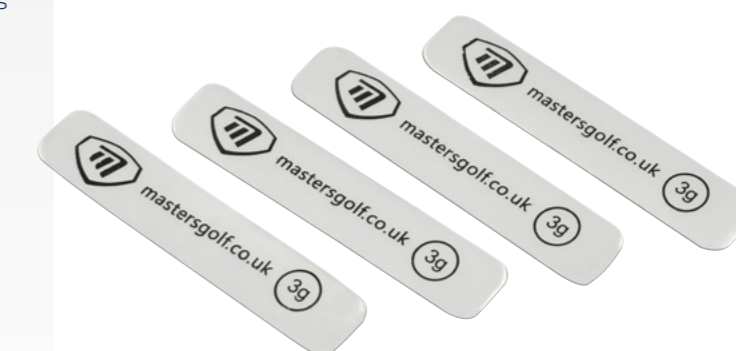

 **MASTERS GOLF**

EDGE PUTTING MIRROR

PUTTING PRACTICE

Includes slots for putter gate, ball gate, and release gate practice drills. The non-skid base makes it perfect for your practice on the green or in the office.

CODE

PE145



360 DEGREE MIRROR

SWING FEEDBACK

Learning new movements or making adjustments are quick and easy because you get instant visual feedback. Mark the mirror with the positions you want and get to work.

CODE

PE163



ALIGNMENT MIRROR

PUTTING PRACTICE

An easy to use Putting Mirror is highly portable and great for checking your setup on the green. Keep it in your bag and use it when you practice or warm up before a round.

CODE

PE146



SHOULDER MIRROR

PUTTING PRACTICE

The 'Shoulder' for the EyeLine Putting Alignment Mirror gives an expanded view of the shoulder alignment. Match your shoulders to the mirror lines and you are ready for more solid, end-over-end rolls.

CODE

PE151

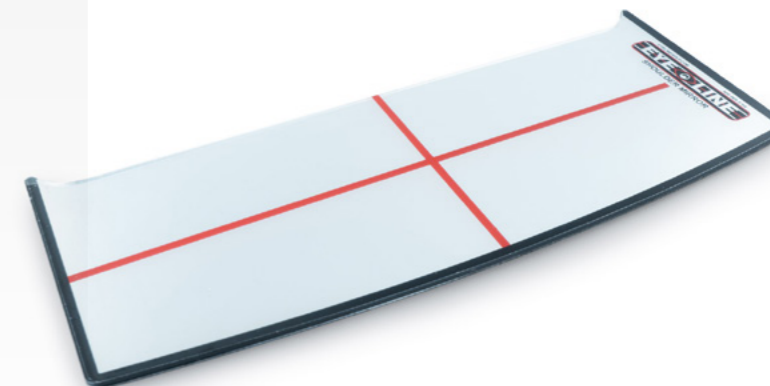

TARGET CIRCLES

CHIPPING PRACTICE

The target circles are super thin so that the ball rolls over the target without disturbance. They can be used in multiple configurations and can be made into full and half circles for all the games your brain can come up with.

CODE

PE150

PE152



SLOWMO SCREEN

PUTTING PRACTICE

Use the SloMo Screen, the MyRoll ball, and your smart phone slo-mo video. Watch the exact roll - or not - of the putt to get instant visual feedback.

CODE

PE169A



LIFELINE PUTTING GRIP

PUTTING PRACTICE

When the putter grip goes through the lifeline of your hand, the hands won't turn the putter off-line. The LifeLine Training Grip creates your perfect grip. The putter shaft and forearms line up, and short putts find the bottom of the cup.

CODE

PE167

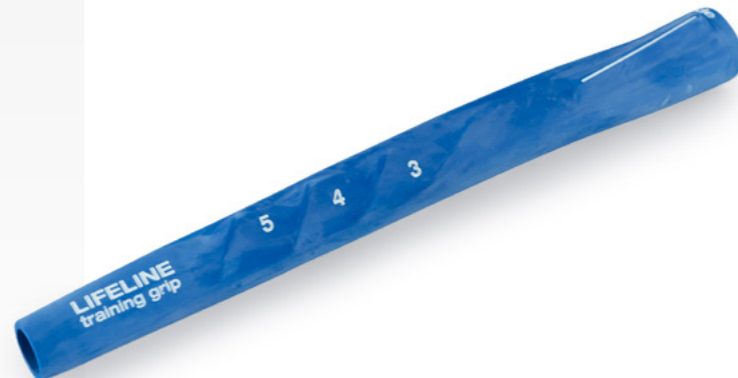

SPEED TRAP

WITH FOAM POWER RODS

The Speed Trap has been developed to help golfers do two things, hit longer and hit straighter.

CODE

PE161



RANGE TEES

FLEXIBLE & DURABLE

For use on practice mats, these tees allow you to carry on playing whatever the weather. Made from flexible, durable rubber, the four sizes allow you to fine-tune your practice session according to the desired club or shot.

CODE	PACK QTY	COLOUR
TER00	1	Various
TER011	100	Blue
TER012	100	Yellow
TER013	100	Pink
TER014	100	Orange



Various



1½"



1⅞"



2¼"



2½"

OUR BRANDS

Our extensive knowledge of the Golf Industry has allowed us to develop a number of unique and innovative in-house brands catering for every sector in golf retail, offering incredible value and excellent margins.

Masters 24/7 is the primary selling vehicle for the business throughout the UK and Europe. It is the 'mothership' brand and the central point from where, you the customer, come to for both product and service. You'll find more detail below about our in-house brands.



In 2017 we made the first steps as a company to distinguish between our service & logistics brand (Masters 24/7) and Masters Golf. The latter is our specialist in-house golf brand that offers a comprehensive range of equipment and accessories. Masters Golf is all about product for purpose and has unbeatable value when it comes to price and quality.



MKids and Golfway are our specialist junior golf product ranges offering progressive playing equipment for young golfers. Recognised for quality and playability throughout UK and Europe, MKids is a great way for youngsters to begin their journey in the game with a range of features to support their development.



The iCart brand offers a range of high specification bags and trolleys as well as accessories. iCart products are produced with a specification of materials and features making it one of the leading golf trolley brands on the market.



Level 4 is our specialist customisation brand offering a huge range of golf products from brassware to headwear that can be personalised with a customer's own brand. We embellish on-site, covering a range of print or embroidery products, making Level 4 a unique reliable option for personalisation customers.



TourDri is the brand that is designed for tackling the elements. Built on the simple principle that products and people need protecting from the harshest of conditions on the course, TourDri products are engineered to respond effectively and never fail. With a range of wet weather equipment from umbrellas to waterproof bags, TourDri is a course favourite.



ClubCraft is everything you'll need for club building and repair. It's our new signpost brand for offering an extensive range of products dedicated to running a technically capable and successful workshop, as well as a huge choice of grips, shafts, tools and machinery.